

CATALOGUE

LED lighting

Electric mobility

M O N F N F M O N O N O N
N N O N M O N F M O F N F
F O M O F M F O F F N O M
N N O M M O N M F O F N F
M O N F N F F O N F N O M
N N O M F O N F F O F N F
O N N **M O O N O F F** O N F
M F F O N F M O N F N O O
F N O M F O O F O O F N F
O O N F F F M N O M M O N
N F F M M O O N F O F N M
F N N F O F M O N M N O N
O N F M O O N O F O F N O



Project: Numancia de la Sagra Town Council
Location: Toledo, Castilla-La Mancha
Luminaire: COANDA Series Start



Index

- 07 – About us
- 12 – Our philosophy
- 17 – Public Lighting
- 75 – Solar lighting
- 81 – Columns and supports
- 87 – Sports and Industrial lighting
- 111 – Horticulture
- 117 – Remote management
- 121 – Mobility
- 127 – Projects
- 153 – Appendix
- 157 – Contact

about us



2012

Year of
foundation

+20

Countries with
presence

+1K

Projects
completed

+150K

Luminaires
installed

Moonoff (Santiago de Compostela, España; 8 May 2012) is a technology company specialising in the **design, development and manufacture of professional LED lighting and smart charging solutions for electric vehicles and plug-in hybrids.**

Headquartered in **Santiago de Compostela**, we have a multidisciplinary, professional and committed team, a fundamental part of transforming the company into a benchmark in the lighting and electric mobility sectors.



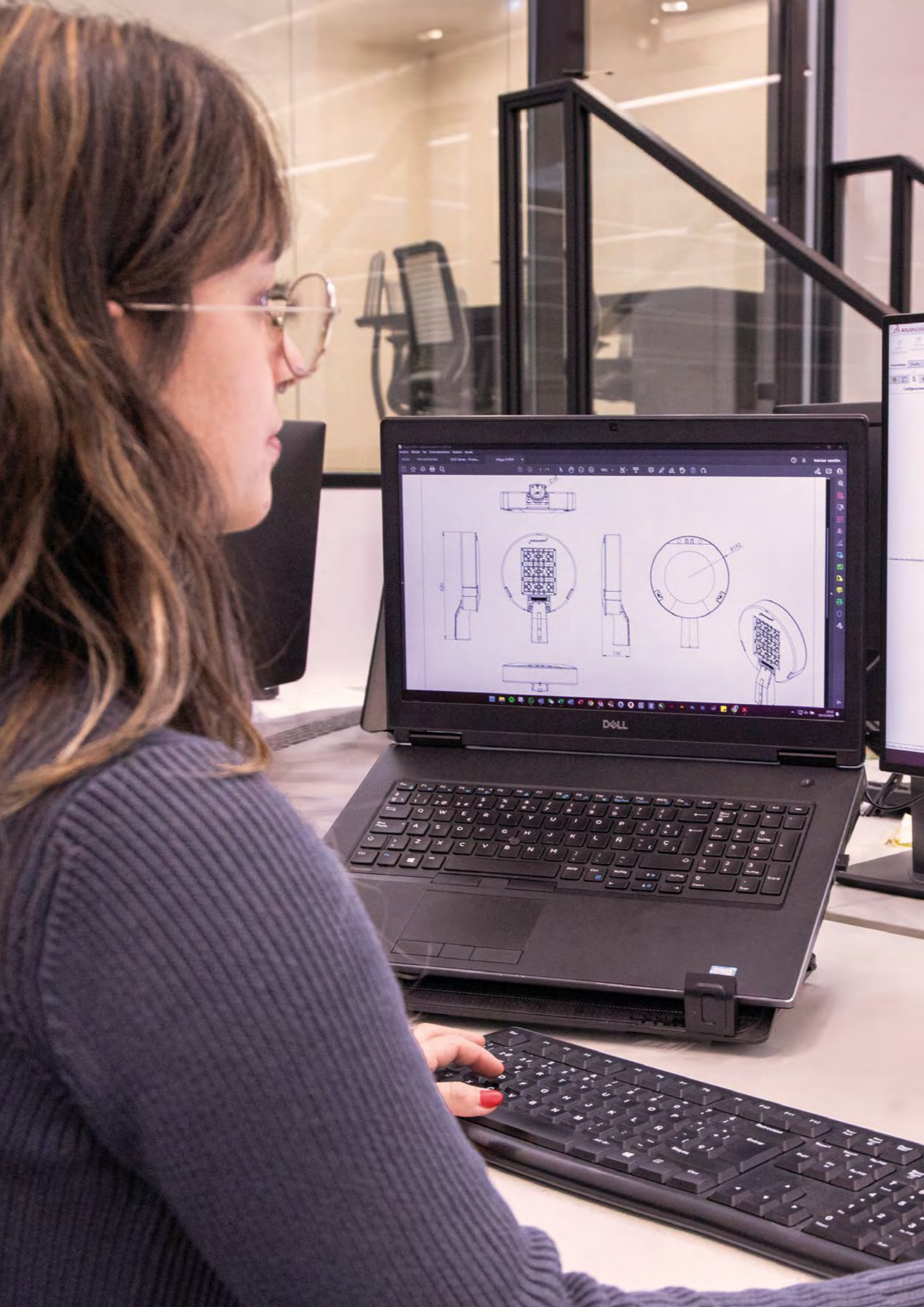

Since our beginnings, we have always believed in and committed to **technological innovation** in order to increase the added value of our products. For this reason, we have an **R&D&I** department responsible for designing and developing all components and all our products, enabling us to offer professional solutions to the market.

Our greatest motivation is **customer satisfaction** which is why throughout the entire development process we take into account all the properties that characterise and add value to the product, thereby giving it a fundamental value: **Quality.**

Our philosophy

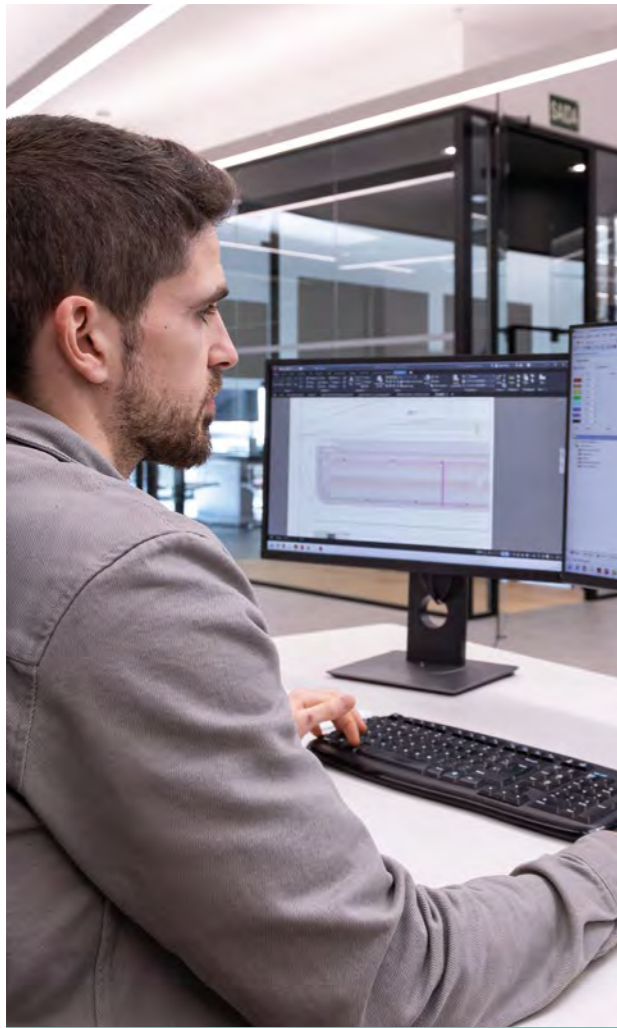

To offer the market **high-quality technical solutions** together with specialised professional support. Winning a new customer is an achievement, but keeping them is a triumph.

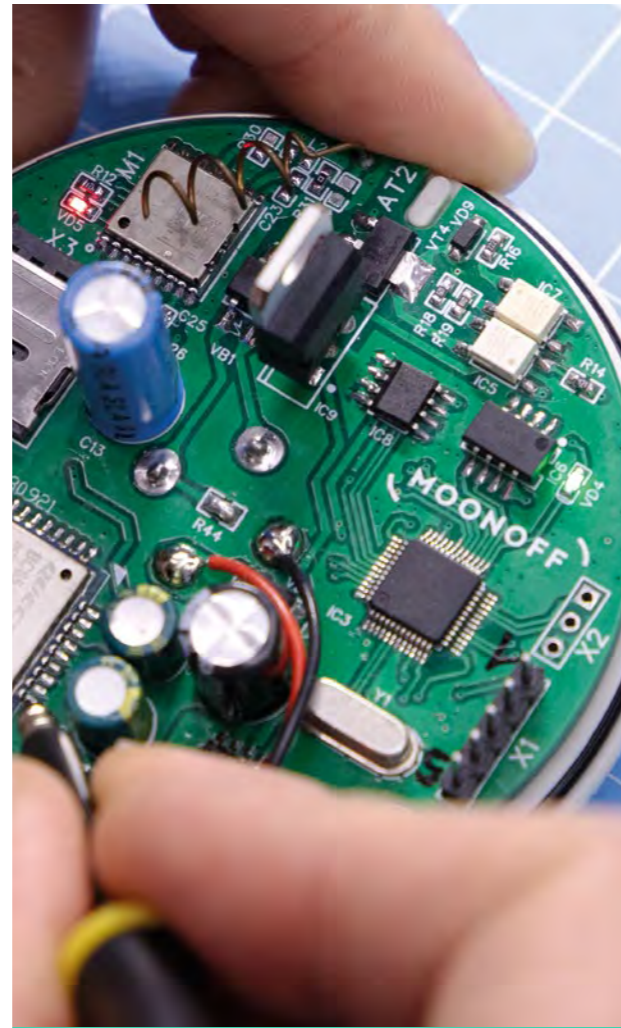

We have our own **R&D&I** department responsible for developing the **most innovative solutions** for our customers, tailored to their interests.



We believe that **diversity and inclusion** are key to success, and that a workforce with equal opportunities allows us to make the most of everyone's talent.

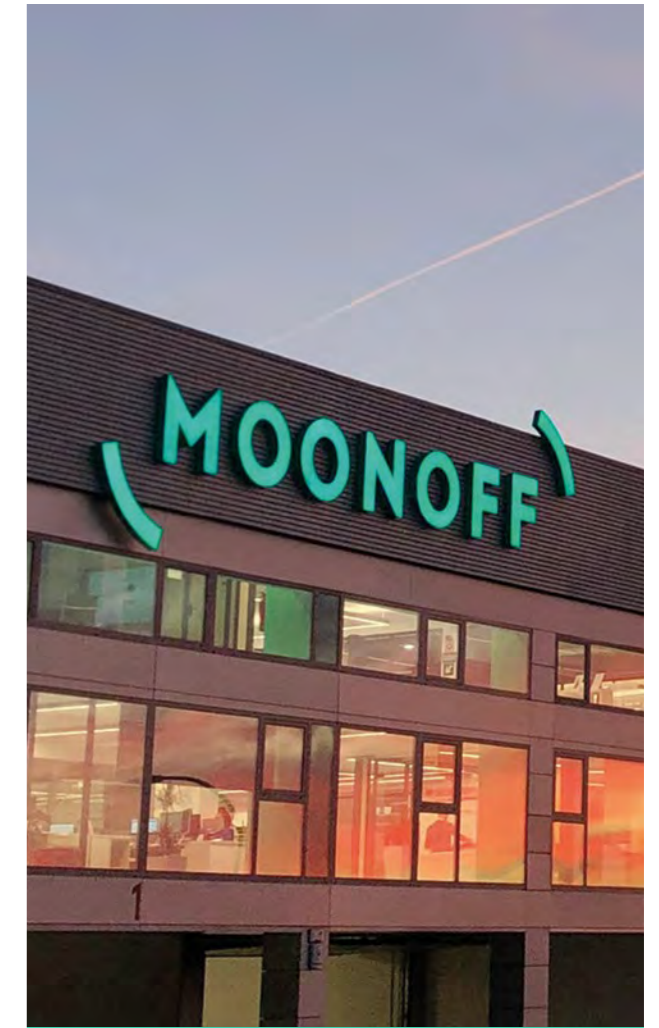

We are committed to **protecting the environment**. We implement sustainable practices in every area of our business, from material selection to waste management, in order to minimise our impact on the planet.

a more sustainable future

At **Moonoff**, our goal is for the products we offer to have lasting value within the economy. To achieve this, we are committed to standardisation, allowing components to be easily replaceable and upgradeable, thereby extending the service life of PUBLIC LIGHTING. In this way, waste generation is minimised and a **circular economy** is promoted.

In addition, we strive to ensure that our PUBLIC LIGHTING projects are **sustainable, recyclable and adaptable** to the future needs of municipalities. In this way, we benefit not only the environment, but also all the stakeholders involved in the management of PUBLIC LIGHTING, including citizens, companies and public administrations.



Project: Fuerzas Armadas Avenue
Location: Huelva, Andalucía
Luminaire: TESLA Series MAX



public lighting

- 18 – **COANDA** Series Mini
- 22 – **COANDA** Series Start
- 26 – **MAGA** Series H
- 30 – **MAGA** Series V
- 34 – **OLO** Series
- 38 – **ESTRADA** Series
- 42 – **TESLA** Series PRO
- 46 – **TESLA** Series MAX
- 50 – **STELLA** Series H
- 54 – **STELLA** Series V
- 58 – **FARO** Series
- 62 – **ROYALTY** Series
- 66 – **FEDORA** Series
- 70 – **LUGA** Series



PUBLIC LIGHTING

COANDA Series Mini - Street light

COANDA

Series Mini

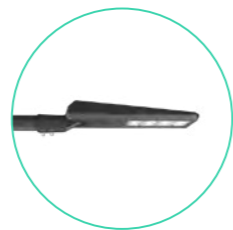

Installation on pole



Installation on column

The **COANDA Series** luminaire family represents a new paradigm in public lighting. With a simple and meticulous design, it integrates elegantly into any urban lighting project.

COANDA Series Mini brings together the most advanced technology developed by Moonoff, offering the market a versatile solution consisting of two series, mainly differentiated by the range of power ratings offered.



Features

- Die-cast aluminium body with stainless steel screws
- Tilt adjustment possible from -20° to +20°
- Configuration: 3000K 70CRI (other configurations available on request)
- Luminous flux maintenance L90 > 100,000 hours
- Different photometric distributions depending on the application
- DALI-2 dimmable driver, adjustable via NFC
- Programmable at fixed power or by power step dimming
- Programmable from the control cabinet (optional)
- Individual surge protection device 20 kV
- Possibility of use with NEMA or ZHAGA socket (lower/upper)
- Tool-free opening

Dimensions

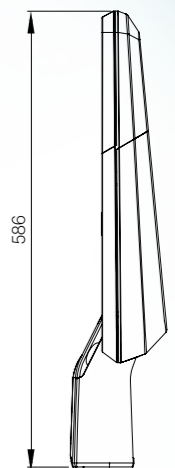
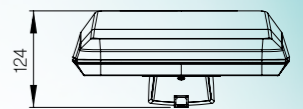
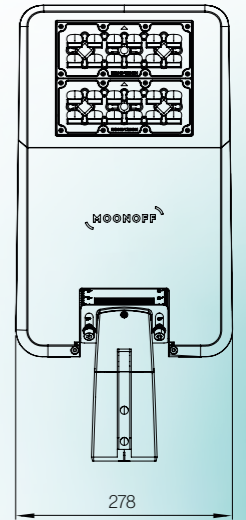
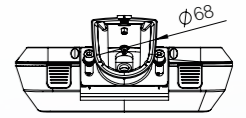

Photometric curves

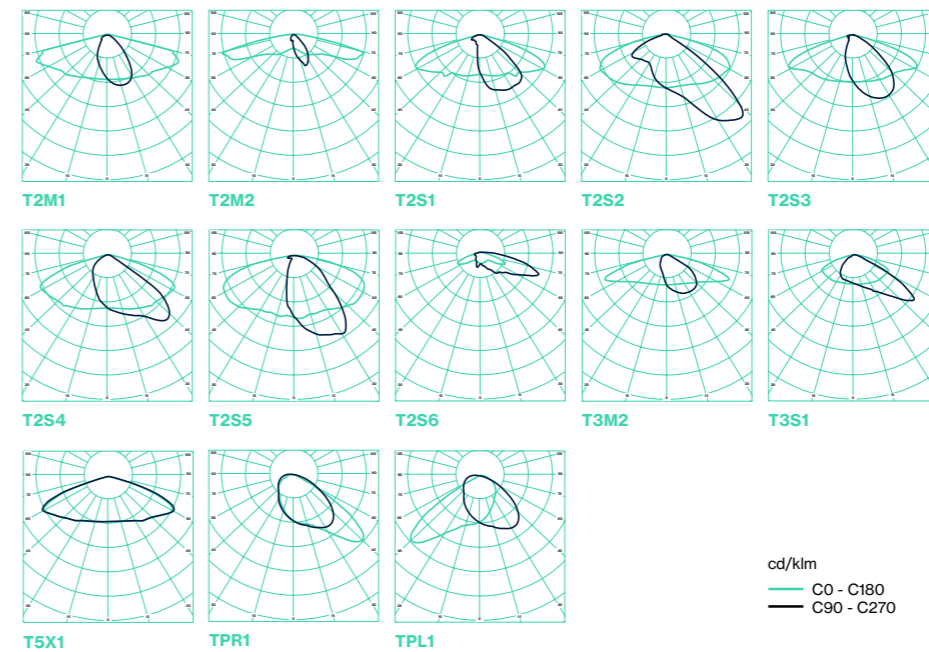

Reference configurator

Model	Power	Optics	CCT	CRI	Driver	Elements	SPD	EL. class	RAL color	Treatment
COM1 Series 1	25W	2M1 Medium T.II	22K 2.200K	7 70	24FL 220-240 VAC Prog. DALI-2, ZH/24V	CL Smooth cover	20P 20kV	1 Class I	GY RAL 7010 grey	A2 250 hrs AISI 304
	40W	2M2 Medium T.II	27K 2.700K	8 80	24T1 220-240 VAC Prog. DALI-2, ZH/24V	ZS Upper Zhaga socket	20C 20kV	2 Class II	** On request	A4 250 hrs AISI 316
	55W	2S1 Short T.II	30K 3.000K	24T2 220-240 VAC Prog. DALI-2	ZI Lower Zhaga socket	B2 500 hrs AISI 304				
		2S2 Short T.II	40K 4.000K				Z2 Upper Zhaga socket + lower	B4 500 hrs AISI 316		
		2S3 Short T.II					NZ Upper NEMA socket + lower Zhaga	C2 1000 hrs AISI 304		
		2S4 Short T.II					S3 3-pin NEMA socket	C4 1000 hrs AISI 316		
		2S5 Short T.II					S5 5-pin NEMA socket	D2 1500 hrs AISI 304		
		2S6 Short T.II					S7 7-pin NEMA socket	D4 1500 hrs AISI 316		
	3M2 Medium T.III		** On request							
	3S1 Short T.III									
	5X1 Symmetric TV									
	PR1 Right pedestrian									
	PL1 Left pedestrian									

References	3.000K	
	Lumens	LPW
COM1-25W2M1-30K7-24FL-CL20P-1_GY-A2	> 3.500	> 140
COM1-40W2M1-30K7-24FL-CL20P-1_GY-A2	> 5.600	> 140
COM1-55W2M1-30K7-24FL-CL20P-1_GY-A2	> 7.700	> 140

References	4.000K	
	Lumens	LPW
COM1-25W2M1-40K7-24FL-CL20P-1_GY-A2	> 3.750	> 150
COM1-40W2M1-40K7-24FL-CL20P-1_GY-A2	> 6.000	> 150
COM1-55W2M1-40K7-24FL-CL20P-1_GY-A2	> 8.250	> 150

NOTE: The luminous flux values may vary depending on the selected luminaire configuration due to the different electrical insulation options, available optics, and the colourimetric and binning parameters of the LED diode.

Reference configurator

Model	Power	Optics	CCT	CRI	Driver	Elements	SPD	EL. class	RAL color	Treatment
COM2 Series 2	25W	2M1 Medium T.II	22K 2.200K	7 70	24DI 220-240 VAC Prog. DALI-2, D4i	CL Smooth cover	20P 20kV	1 Class I	GY RAL 7010 grey	A2 250 hrs AISI 304
	40W	2M2 Medium T.II	27K 2.700K	8 80	24FL 220-240 VAC Prog. DALI-2, ZH/24V	ZS Upper Zhaga socket	20C 20kV	2 Class II	** On request	A4 250 hrs AISI 316
	60W	2S1 Short T.II	30K 3.000K	24T2 220-240 VAC Prog. DALI-2	ZI Lower Zhaga socket	B2 500 hrs AISI 304				
		2S2 Short T.II	40K 4.000K				Z2 Upper Zhaga socket + lower	B4 500 hrs AISI 316		
		2S3 Short T.II					NZ Upper NEMA socket + lower Zhaga	C2 1000 hrs AISI 304		
		2S4 Short T.II					S3 3-pin NEMA socket	C4 1000 hrs AISI 316		
		2S5 Short T.II					S5 5-pin NEMA socket	D2 1500 hrs AISI 304		
		2S6 Short T.II					S7 7-pin NEMA socket	D4 1500 hrs AISI 316		
	3M2 Medium T.III		** On request							
	3S1 Short T.III									
	5X1 Symmetric TV									
	PR1 Right pedestrian									
	PL1 Left pedestrian									

References	3.000K	
	Lumens	LPW
COM2-25W2M1-30K7-24FL-CL20P-1_GY-A2	> 3.375	> 135
COM2-40W2M1-30K7-24FL-CL20P-1_GY-A2	> 5.400	> 135
COM2-60W2M1-30K7-24FL-CL20P-1_GY-A2	> 8.100	> 135
COM2-80W2M1-30K7-24FL-CL20P-1_GY-A2	> 10.000	> 125

References	4.000K	
	Lumens	LPW
COM2-25W2M1-40K7-24FL-CL20P-1_GY-A2	> 3.625	> 145
COM2-40W2M1-40K7-24FL-CL20P-1_GY-A2	> 5.800	> 145
COM2-60W2M1-40K7-24FL-CL20P-1_GY-A2	> 8.700	> 145
COM2-80W2M1-40K7-24FL-CL20P-1_GY-A2	> 10.800	> 135

NOTE: The luminous flux values may vary depending on the selected luminaire configuration due to the different electrical insulation options, available optics, and the colourimetric and binning parameters of the LED diode.



PUBLIC LIGHTING

COANDA Series Start - Street light

COANDA Series Start



Installation on pole



Installation on column

The **COANDA Series** luminaire family represents a new paradigm in public lighting. With a simple and meticulous design, it integrates elegantly into any urban lighting project.

COANDA Series Start brings together the most advanced technology developed by Moonoff, offering the market a versatile solution consisting of two series, mainly differentiated by the range of power ratings offered.



Features

- Die-cast aluminium body with stainless steel screws
- Tilt adjustment possible from -20° to +20°
- Configuration: 3000K 70CRI (other configurations available on request)
- Luminous flux maintenance L90 > 100,000 hours
- Different photometric distributions depending on the application
- DALI-2 dimmable driver, adjustable via NFC
- Programmable at fixed power or by power step dimming
- Programmable from the control cabinet (optional)
- Individual surge protection device 20 kV
- Possibility of use with NEMA or ZHAGA socket (lower/upper)
- Tool-free opening

Dimensions

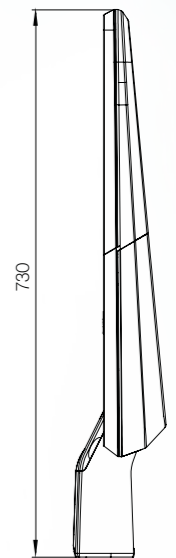
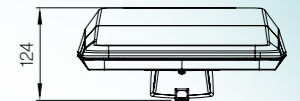
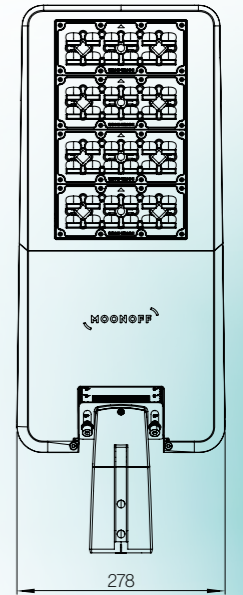
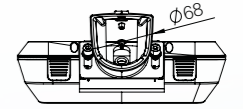

Photometric curves

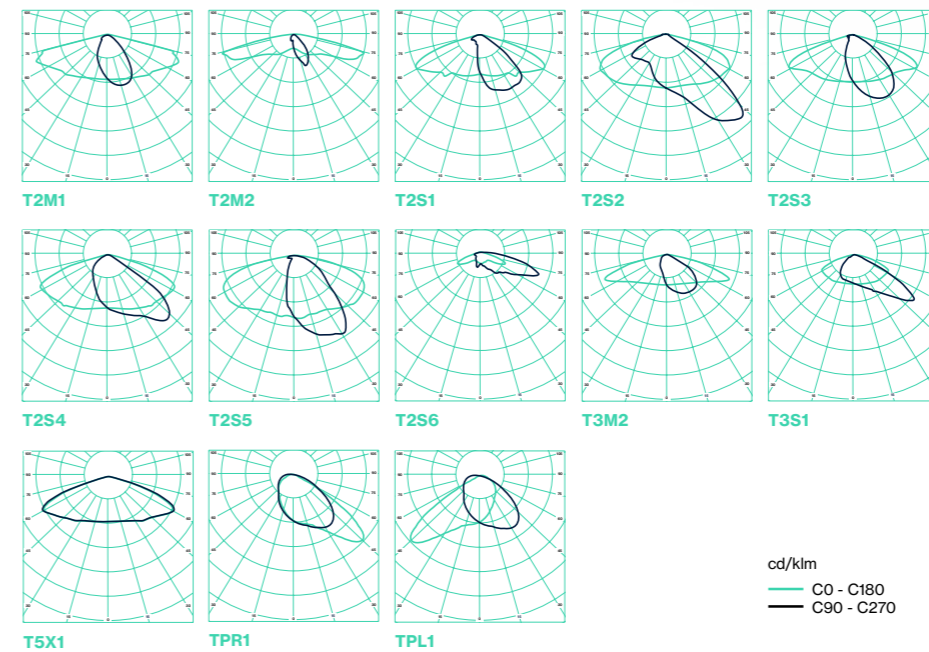

Reference configurator

Model	Power	Optics	CCT	CRI	Driver	Elements	SPD	EL. class	RAL color	Treatment
COS1 Series 1	75W	2M1 Medium T.II	22K 2.200K	7 70	24FL 220-240 VAC Prog. DALI-2, ZH/24V	CL Smooth cover	20P 20kV	1 Class I	GY RAL 7010 grey	A2 250 hrs AISI 304
		2M2 Medium T.II	27K 2.700K	8 80		24T1 220-240 VAC Prog. DALI-2, ZH/24V				ZS Upper Zhaga socket
		2S1 Short T.II	30K 3.000K		24T2 220-240 VAC Prog. DALI-2	ZI Lower Zhaga socket				B2 500 hrs AISI 304
		2S2 Short T.II	40K 4.000K			Z2 Upper Zhaga socket + lower				B4 500 hrs AISI 316
		2S3 Short T.II				NZ Upper NEMA socket + lower Zhaga				C2 1000 hrs AISI 304
		2S4 Short T.II				S3 3-pin NEMA socket				C4 1000 hrs AISI 316
		2S5 Short T.II				S5 5-pin NEMA socket				D2 1500 hrs AISI 304
		2S6 Short T.II				S7 7-pin NEMA socket				D4 1500 hrs AISI 316
		3M2 Medium T.III								** On request
		3S1 Short T.III								
		5X1 Symmetric TV								
		PR1 Right pedestrian								
		PL1 Left pedestrian								

References	3.000K	
	Lumens	LPW
COS1-75W2M1-30K7-24FL-CL20P-1_GY-A2	> 10.500	> 140
COS1-100W2M1-30K7-24FL-CL20P-1_GY-A2	> 14.000	> 140

References	4.000K	
	Lumens	LPW
COS1-75W2M1-40K7-24FL-CL20P-1_GY-A2	> 11.250	> 150
COS1-100W2M1-40K7-24FL-CL20P-1_GY-A2	> 15.000	> 150

NOTE: The luminous flux values may vary depending on the selected luminaire configuration due to the different electrical insulation options, available optics, and the colourimetric and binning parameters of the LED diode.

Reference configurator

Model	Power	Optics	CCT	CRI	Driver	Elements	SPD	EL. class	RAL color	Treatment
COS2 Series 2	120W	2M1 Medium T.II	22K 2.200K	7 70	24DI 220-240 VAC Prog. DALI-2, D4I	CL Smooth cover	20P 20kV	1 Class I	GY RAL 7010 grey	A2 250 hrs AISI 304
		160W	2M2 Medium T.II	27K 2.700K		8 80				24FL 220-240 VAC Prog. DALI-2, ZH/24V
		2S1 Short T.II	30K 3.000K		24T2 220-240 VAC Prog. DALI-2	ZI Lower Zhaga socket				B2 500 hrs AISI 304
		2S2 Short T.II	40K 4.000K		27I1 100-277 VAC Prog. DALI-2	Z2 Upper Zhaga socket + lower				B4 500 hrs AISI 316
		2S3 Short T.II				NZ Upper NEMA socket + lower Zhaga				C2 1000 hrs AISI 304
		2S4 Short T.II				S3 3-pin NEMA socket				C4 1000 hrs AISI 316
		2S5 Short T.II				S5 5-pin NEMA socket				D2 1500 hrs AISI 304
		2S6 Short T.II				S7 7-pin NEMA socket				D4 1500 hrs AISI 316
		3M2 Medium T.III								** On request
		3S1 Short T.III								
		5X1 Symmetric TV								
		PR1 Right pedestrian								
		PL1 Left pedestrian								

References	3.000K	
	Lumens	LPW
COS2-120W2M1-30K7-24FL-CL20P-1_GY-A2	> 16.200	> 135
COS2-160W2M1-30K7-24FL-CL20P-1_GY-A2	> 20.000	> 125

References	4.000K	
	Lumens	LPW
COS2-120W2M1-40K7-24FL-CL20P-1_GY-A2	> 17.400	> 145
COS2-160W2M1-40K7-24FL-CL20P-1_GY-A2	> 21.600	> 135

NOTE: The luminous flux values may vary depending on the selected luminaire configuration due to the different electrical insulation options, available optics, and the colourimetric and binning parameters of the LED diode.



PUBLIC LIGHTING

MAGA Series H - Garden light

MAGA

Series H



Installation on pole



Installation on column

The **MAGA Series** luminaire family by Moonoff redefines the concept of public lighting. Its simple and meticulous design integrates naturally into any urban project, adding a touch of elegance and modernity.

MAGA Series brings together Moonoff's most advanced technology, offering the market a versatile solution in two series, mainly differentiated by the range of power ratings available. In this way, it adapts to the specific needs of each project, from streets and avenues to pedestrian areas and parks.



Features

- Die-cast aluminium body with stainless steel screws
- Tilt adjustment possible from -20° to +20°
- Configuration: 3000K 70CRI (other configurations available on request)
- Luminous flux maintenance L90 > 100,000 hours
- Different photometric distributions depending on the application
- DALI-2 dimmable driver, adjustable via NFC
- Programmable at fixed power or by power step dimming
- Programmable from the control cabinet (optional)
- Individual surge protection device 20 kV
- Possibility of use with NEMA or ZHAGA socket (lower/upper)
- Tool-free opening

Photometric curves

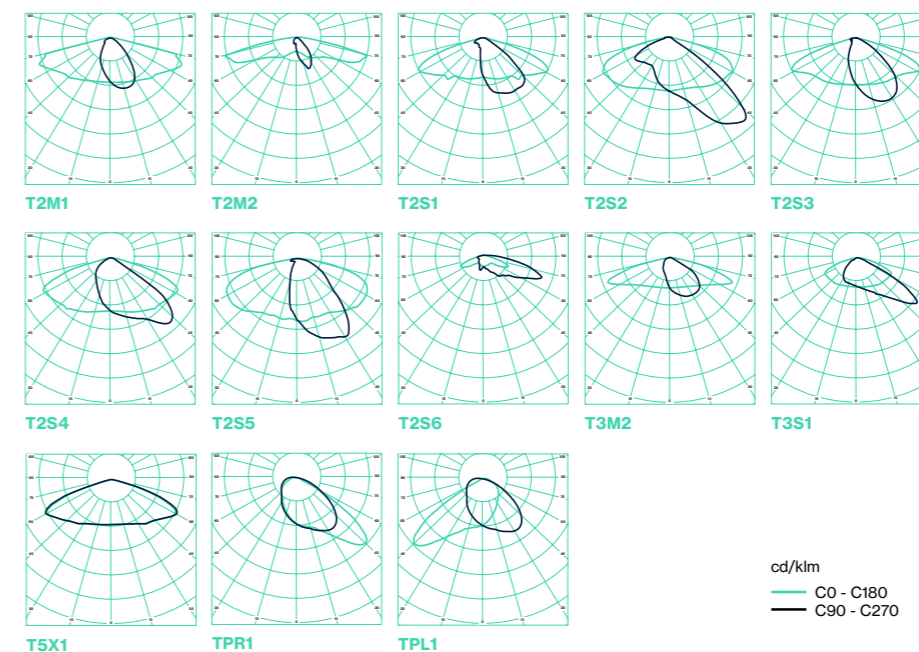

Dimensions

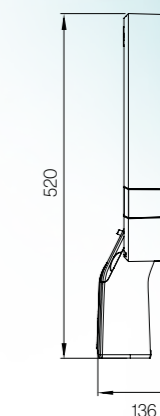
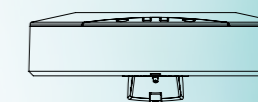
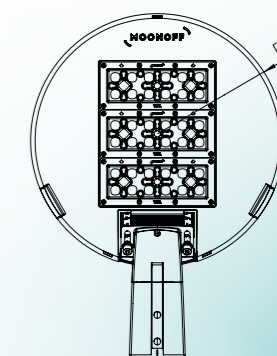
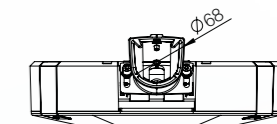

Reference configurator

Model	Power	Optics	CCT	CRI	Driver	Elements	SPD	EL. class	RAL color	Treatment
MAH1 Series 1	25W	2M1 Medium T.II	22K 2.200K	7 70	24FL 220-240 VAC Prog. DALI-2, ZH/24V	CL Smooth cover	20P 20kV	1 Class I	GY RAL 7010 grey	A2 250 hrs AISI 304
	40W	2M2 Medium T.II	27K 2.700K	8 80	24T1 220-240 VAC Prog. DALI-2, ZH/24V	ZS Upper Zhaga socket	20C 20kV	2 Class II	** On request	A4 250 hrs AISI 316
	55W	2S1 Short T.II	30K 3.000K		24T2 220-240 VAC Prog. DALI-2	ZI Lower Zhaga socket				B2 500 hrs AISI 304
	75W	2S2 Short T.II	40K 4.000K			Z2 Upper Zhaga socket + lower				B4 500 hrs AISI 316
		2S3 Short T.II				NZ Upper NEMA socket + lower Zhaga				C2 1000 hrs AISI 304
		2S4 Short T.II				S3 3-pin NEMA socket				C4 1000 hrs AISI 316
		2S5 Short T.II				S5 5-pin NEMA socket				D2 1500 hrs AISI 304
		2S6 Short T.II				S7 7-pin NEMA socket				D4 1500 hrs AISI 316
		3M2 Medium T.III								** On request
		3S1 Short T.III								
		5X1 Symmetric TV								
		PR1 Right pedestrian								
		PL1 Left pedestrian								

References	3.000K	
	Lumens	LPW
MAH1-25W2M1-30K7-24FL-CL20P-1_GY-A2	> 3.500	> 140
MAH1-40W2M1-30K7-24FL-CL20P-1_GY-A2	> 5.600	> 140
MAH1-55W2M1-30K7-24FL-CL20P-1_GY-A2	> 7.700	> 140
MAH1-75W2M1-30K7-24FL-CL20P-1_GY-A2	> 10.500	> 140

References	4.000K	
	Lumens	LPW
MAH1-25W2M1-40K7-24FL-CL20P-1_GY-A2	> 3.750	> 150
MAH1-40W2M1-40K7-24FL-CL20P-1_GY-A2	> 6.000	> 150
MAH1-55W2M1-40K7-24FL-CL20P-1_GY-A2	> 8.250	> 150
MAH1-75W2M1-40K7-24FL-CL20P-1_GY-A2	> 11.250	> 150

NOTE: The luminous flux values may vary depending on the selected luminaire configuration due to the different electrical insulation options, available optics, and the colourimetric and binning parameters of the LED diode.

Reference configurator

Model	Power	Optics	CCT	CRI	Driver	Elements	SPD	EL. class	RAL color	Treatment
MAH2 Series 2	25W	2M1 Medium T.II	22K 2.200K	7 70	24DI 220-240 VAC Prog. DALI-2, D4i	CL Smooth cover	20P 20kV	1 Class I	GY RAL 7010 grey	A2 250 hrs AISI 304
	40W	2M2 Medium T.II	27K 2.700K	8 80	24FL 220-240 VAC Prog. DALI-2, ZH/24V	ZS Upper Zhaga socket	20C 20kV	2 Class II	** On request	A4 250 hrs AISI 316
	60W	2S1 Short T.II	30K 3.000K		24T2 220-240 VAC Prog. DALI-2	ZI Lower Zhaga socket				B2 500 hrs AISI 304
	80W	2S2 Short T.II	40K 4.000K		27H1 100-277 VAC Prog. DALI-2	Z2 Upper Zhaga socket + lower				B4 500 hrs AISI 316
	120W	2S3 Short T.II				NZ Upper NEMA socket + lower Zhaga				C2 1000 hrs AISI 304
		2S4 Short T.II				S3 3-pin NEMA socket				C4 1000 hrs AISI 316
		2S5 Short T.II				S5 5-pin NEMA socket				D2 1500 hrs AISI 304
		2S6 Short T.II				S7 7-pin NEMA socket				D4 1500 hrs AISI 316
		3M2 Medium T.III								** On request
		3S1 Short T.III								
		5X1 Symmetric TV								
		PR1 Right pedestrian								
		PL1 Left pedestrian								

References	3.000K	
	Lumens	LPW
MAH2-25W2M1-30K7-24FL-CL20P-1_GY-A2	> 3.375	> 135
MAH2-40W2M1-30K7-24FL-CL20P-1_GY-A2	> 5.400	> 135
MAH2-60W2M1-30K7-24FL-CL20P-1_GY-A2	> 8.100	> 135
MAH2-80W2M1-30K7-24FL-CL20P-1_GY-A2	> 10.000	> 125
MAH2-120W2M1-30K7-24FL-CL20P-1_GY-A2	> 16.200	> 135

References	4.000K	
	Lumens	LPW
MAH2-25W2M1-40K7-24FL-CL20P-1_GY-A2	> 3.625	> 145
MAH2-40W2M1-40K7-24FL-CL20P-1_GY-A2	> 5.800	> 145
MAH2-60W2M1-40K7-24FL-CL20P-1_GY-A2	> 8.700	> 145
MAH2-80W2M1-40K7-24FL-CL20P-1_GY-A2	> 10.800	> 135
MAH2-120W2M1-40K7-24FL-CL20P-1_GY-A2	> 17.400	> 145

NOTE: The luminous flux values may vary depending on the selected luminaire configuration due to the different electrical insulation options, available optics, and the colourimetric and binning parameters of the LED diode.



PUBLIC LIGHTING

MAGA Series V - Garden light

MAGA Series V



Installation on column

The **MAGA Series** luminaire family by Moonoff redefines the concept of public lighting. Its simple and meticulous design integrates naturally into any urban project, adding a touch of elegance and modernity.

MAGA Series brings together Moonoff's most advanced technology, offering the market a versatile solution in two series, mainly differentiated by the range of power ratings available. In this way, it adapts to the specific needs of each project, from streets and avenues to pedestrian areas and parks.



Features

- Die-cast aluminium body with stainless steel screws
- Tilt adjustment possible from -20° to +20°
- Configuration: 3000K 70CRI (other configurations available on request)
- Luminous flux maintenance L90 > 100,000 hours
- Different photometric distributions depending on the application
- DALI-2 dimmable driver, adjustable via NFC
- Programmable at fixed power or by power step dimming
- Programmable from the control cabinet (optional)
- Individual surge protection device 20 kV
- Possibility of use with NEMA or ZHAGA socket (lower/upper)
- Tool-free opening

Photometric curves

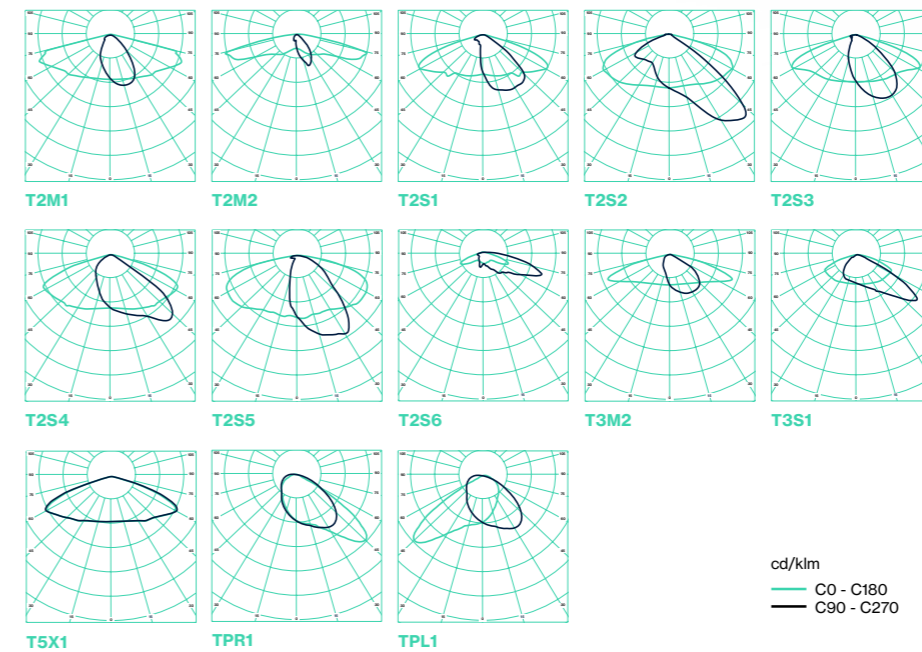

Dimensions

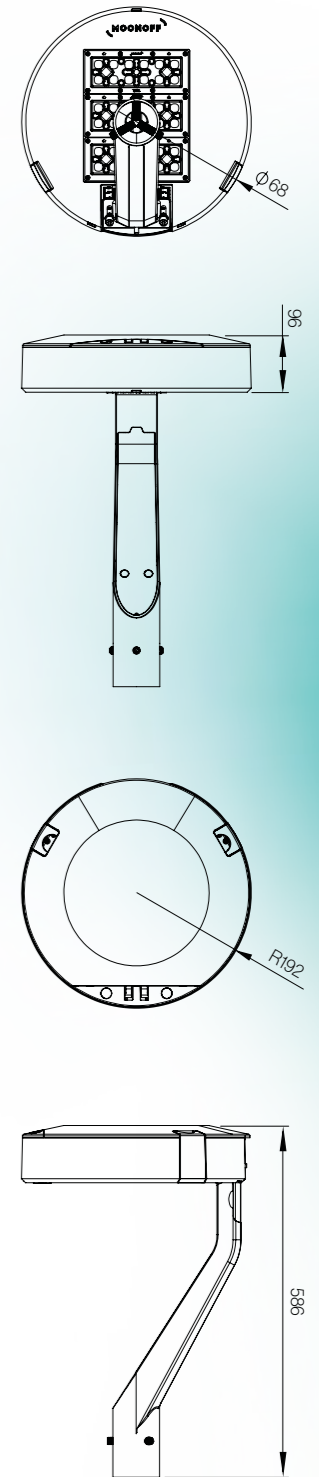

Reference configurator

Model	Power	Optics	CCT	CRI	Driver	Elements	SPD	EL. class	RAL color	Treatment
MAV1 Series 1	25W	2M1 Medium T.II	22K 2.200K	7 70	24FL 220-240 VAC Prog. DALI-2, ZH/24V	CL Smooth cover	20P 20kV	1 Class I	GY RAL 7010 grey	A2 250 hrs AISI 304
	40W	2M2 Medium T.II	27K 2.700K	8 80	24T1 220-240 VAC Prog. DALI-2, ZH/24V	ZS Upper Zhaga socket	20C 20kV	2 Class II	** On request	A4 250 hrs AISI 316
	55W	2S1 Short T.II	30K 3.000K		24T2 220-240 VAC Prog. DALI-2	ZI Lower Zhaga socket				B2 500 hrs AISI 304
	75W	2S2 Short T.II	40K 4.000K			Z2 Upper Zhaga socket + lower				B4 500 hrs AISI 316
		2S3 Short T.II				NZ Upper NEMA socket + lower Zhaga				C2 1000 hrs AISI 304
		2S4 Short T.II				S3 3-pin NEMA socket				C4 1000 hrs AISI 316
		2S5 Short T.II				S5 5-pin NEMA socket				D2 1500 hrs AISI 304
		2S6 Short T.II				S7 7-pin NEMA socket				D4 1500 hrs AISI 316
		3M2 Medium T.III								** On request
		3S1 Short T.III								
		5X1 Symmetric TV								
		PR1 Right pedestrian								
		PL1 Left pedestrian								

References	3.000K	
	Lumens	LPW
MAV1-25W2M1-30K7-24FL-CL20P-1_GY-A2	> 3.500	> 140
MAV1-40W2M1-30K7-24FL-CL20P-1_GY-A2	> 5.600	> 140
MAV1-55W2M1-30K7-24FL-CL20P-1_GY-A2	> 7.700	> 140
MAV1-75W2M1-30K7-24FL-CL20P-1_GY-A2	> 10.500	> 140

References	4.000K	
	Lumens	LPW
MAV1-25W2M1-40K7-24FL-CL20P-1_GY-A2	> 3.750	> 150
MAV1-40W2M1-40K7-24FL-CL20P-1_GY-A2	> 6.000	> 150
MAV1-55W2M1-40K7-24FL-CL20P-1_GY-A2	> 8.250	> 150
MAV1-75W2M1-40K7-24FL-CL20P-1_GY-A2	> 11.250	> 150

NOTE: The luminous flux values may vary depending on the selected luminaire configuration due to the different electrical insulation options, available optics, and the colourimetric and binning parameters of the LED diode.

Reference configurator

Model	Power	Optics	CCT	CRI	Driver	Elements	SPD	EL. class	RAL color	Treatment
MAV2 Series 2	25W	2M1 Medium T.II	22K 2.200K	7 70	24DI 220-240 VAC Prog. DALI-2, D4i	CL Smooth cover	20P 20kV	1 Class I	GY RAL 7010 grey	A2 250 hrs AISI 304
	40W	2M2 Medium T.II	27K 2.700K	8 80	24FL 220-240 VAC Prog. DALI-2, ZH/24V	ZS Upper Zhaga socket	20C 20kV	2 Class II	** On request	A4 250 hrs AISI 316
	60W	2S1 Short T.II	30K 3.000K		24T2 220-240 VAC Prog. DALI-2	ZI Lower Zhaga socket				B2 500 hrs AISI 304
	80W	2S2 Short T.II	40K 4.000K		27H 100-277 VAC Prog. DALI-2	Z2 Upper Zhaga socket + lower				B4 500 hrs AISI 316
	120W	2S3 Short T.II				NZ Upper NEMA socket + lower Zhaga				C2 1000 hrs AISI 304
		2S4 Short T.II				S3 3-pin NEMA socket				C4 1000 hrs AISI 316
		2S5 Short T.II				S5 5-pin NEMA socket				D2 1500 hrs AISI 304
		2S6 Short T.II				S7 7-pin NEMA socket				D4 1500 hrs AISI 316
		3M2 Medium T.III								** On request
		3S1 Short T.III								
		5X1 Symmetric TV								
		PR1 Right pedestrian								
		PL1 Left pedestrian								

References	3.000K	
	Lumens	LPW
MAV2-25W2M1-30K7-24FL-CL20P-1_GY-A2	> 3.375	> 135
MAV2-40W2M1-30K7-24FL-CL20P-1_GY-A2	> 5.400	> 135
MAV2-60W2M1-30K7-24FL-CL20P-1_GY-A2	> 8.100	> 135
MAV2-80W2M1-30K7-24FL-CL20P-1_GY-A2	> 10.000	> 125
MAV2-120W2M1-30K7-24FL-CL20P-1_GY-A2	> 16.200	> 135

References	4.000K	
	Lumens	LPW
MAV2-25W2M1-40K7-24FL-CL20P-1_GY-A2	> 3.625	> 145
MAV2-40W2M1-40K7-24FL-CL20P-1_GY-A2	> 5.800	> 145
MAV2-60W2M1-40K7-24FL-CL20P-1_GY-A2	> 8.700	> 145
MAV2-80W2M1-40K7-24FL-CL20P-1_GY-A2	> 10.800	> 135
MAV2-120W2M1-40K7-24FL-CL20P-1_GY-A2	> 17.400	> 145

NOTE: The luminous flux values may vary depending on the selected luminaire configuration due to the different electrical insulation options, available optics, and the colourimetric and binning parameters of the LED diode.



OLO Series



Features

- Aluminium sheet with stainless steel screws
- Configuration: 3000K 70CRI (other configurations available on request)
- Luminous flux maintenance L90 > 100,000 hours
- Different photometric distributions depending on the application
- DALI-2 dimmable driver, adjustable via NFC
- Programmable at fixed power or by power step dimming
- Programmable from the control cabinet (optional)
- Individual surge protection device 20 kV
- Posibilidad de uso con socket ZHAGA
- Tool-free opening and connection in watertight box

Dimensions

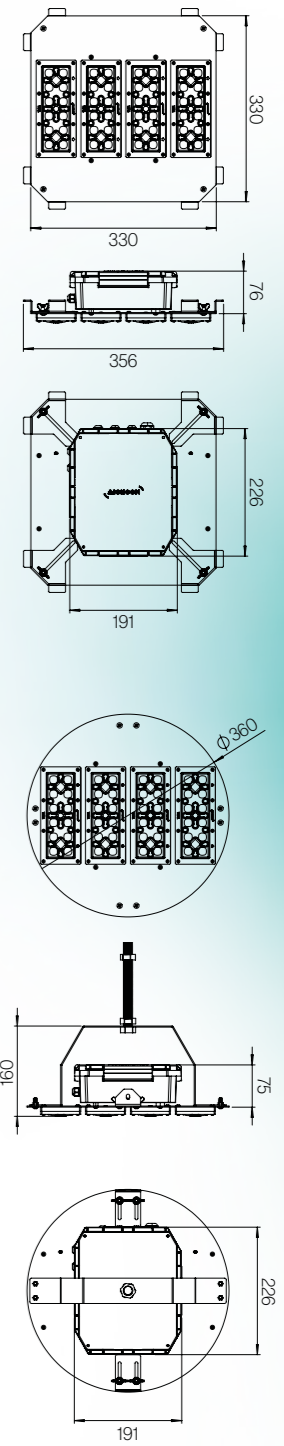

Photometric curves

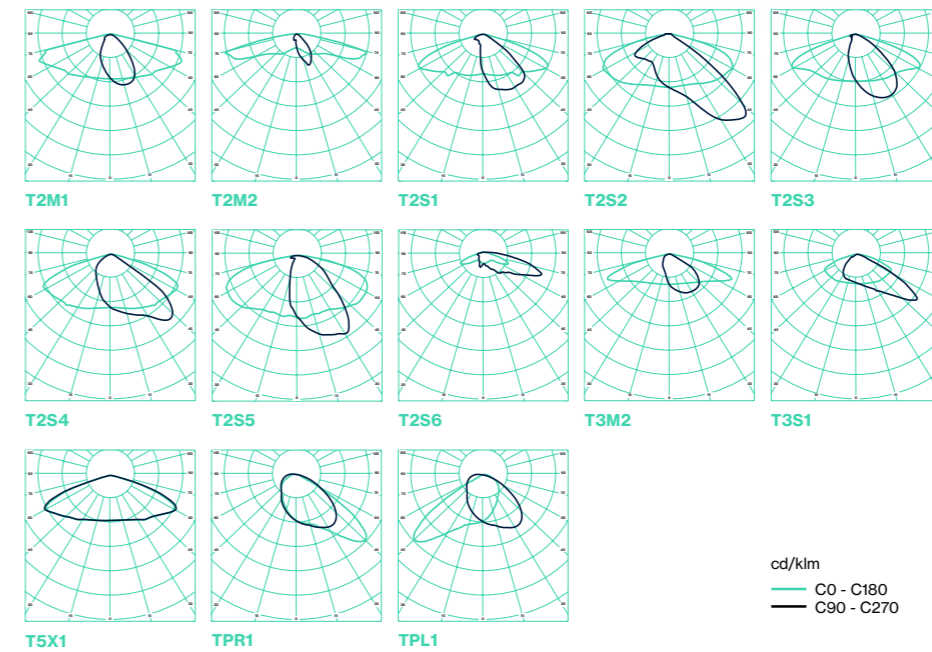

The **OLO Series** module represents a major step forward in luminaire modernisation systems thanks to its advanced technical features. It offers great configuration flexibility, using standardised components to ensure a long service life and facilitate future replacement and upgrading.

With a maximum power of 100 W, OLO Series is positioned as an innovative retrofit system that simplifies installation and enables the connection of communication nodes or sensors, turning luminaires into smart devices.



Reference configurator

Model	Power	Optics	CCT	CRI	Driver	Elements	SPD	EL. class	RAL color	Treatment	
OLO1 Series 1	25W	2M1 Medium T.II	22K 2.200K	7 70	24FL 220-240 VAC Prog. DALI-2, ZH/24V	1C Square laminar structure	20P 20kV	1 Class I	BK RAL 9005 black	A2 250 hrs AISI 304	
	40W	2M2 Medium T.II	27K 2.700K	8 80	24T1 220-240 VAC Prog. DALI-2, ZH/24V	1D Circular laminar structure	20C 20kV	2 Class II	** On request	A4 250 hrs AISI 316	
	55W	2S1 Short T.II	30K 3.000K		24T2 220-240 VAC Prog. DALI-2	ZC Zhaga socket + square sheet				B2 500 hrs AISI 304	
	75W¹	2S2 Short T.II	40K 4.000K			ZD Zhaga socket + circular sheet				B4 500 hrs AISI 316	
	100W	2S3 Short T.II									C2 1000 hrs AISI 304
		2S4 Short T.II									C4 1000 hrs AISI 316
		2S5 Short T.II									D2 1500 hrs AISI 304
		2S6 Short T.II									D4 1500 hrs AISI 316
		3M2 Medium T.III									** On request
		3S1 Short T.III									
		5X1 Symmetric TV									
		PR1 Right pedestrian									
		PL1 Left pedestrian									

¹ Maximum power available for the 24T1 driver

References	3.000K	
	Lumens	LPW
OLO1-25W2M1-30K7-24FL-1C20P-1_GY-A2	> 3.500	> 140
OLO1-40W2M1-30K7-24FL-1C20P-1_GY-A2	> 5.600	> 140
OLO1-55W2M1-30K7-24FL-1C20P-1_GY-A2	> 7.700	> 140
OLO1-75W2M1-30K7-24FL-1C20P-1_GY-A2	> 10.500	> 140
OLO1-100W2M1-30K7-24FL-1C20P-1_GY-A2	> 14.000	> 140

References	4.000K	
	Lumens	LPW
OLO1-25W2M1-40K7-24FL-1C20P-1_GY-A2	> 3.750	> 150
OLO1-40W2M1-40K7-24FL-1C20P-1_GY-A2	> 6.000	> 150
OLO1-55W2M1-40K7-24FL-1C20P-1_GY-A2	> 8.250	> 150
OLO1-75W2M1-40K7-24FL-1C20P-1_GY-A2	> 11.250	> 150
OLO1-100W2M1-40K7-24FL-1C20P-1_GY-A2	> 15.000	> 150

NOTE: The luminous flux values may vary depending on the selected luminaire configuration due to the different electrical insulation options, available optics, and the colourimetric and binning parameters of the LED diode.

Reference configurator

Model	Power	Optics	CCT	CRI	Driver	Elements	SPD	EL. class	RAL color	Treatment	
OLO2 Series 2	25W	2M1 Medium T.II	22K 2.200K	7 70	24DI 220-240 VAC Prog. DALI-2, D4i	1C Square laminar structure	20P 20kV	1 Class I	BK RAL 9005 black	A2 250 hrs AISI 304	
	40W	2M2 Medium T.II	27K 2.700K	8 80	24FL 220-240 VAC Prog. DALI-2, ZH/24V	1D Circular laminar structure	20C 20kV	2 Class II	** On request	A4 250 hrs AISI 316	
	50W	2S1 Short T.II	30K 3.000K		24T2 220-240 VAC Prog. DALI-2	ZC Zhaga socket + square sheet				B2 500 hrs AISI 304	
	60W	2S2 Short T.II	40K 4.000K		27I1 100-277 VAC Prog. DALI-2	ZD Zhaga socket + circular sheet				B4 500 hrs AISI 316	
	80W	2S3 Short T.II									C2 1000 hrs AISI 304
		2S4 Short T.II									C4 1000 hrs AISI 316
		2S5 Short T.II									D2 1500 hrs AISI 304
		2S6 Short T.II									D4 1500 hrs AISI 316
		3M2 Medium T.III									** On request
		3S1 Short T.III									
		5X1 Symmetric TV									
		PR1 Right pedestrian									
		PL1 Left pedestrian									

References	3.000K	
	Lumens	LPW
OLO2-25W2M1-30K7-24FL-1C20P-1_GY-A2	> 3.375	> 135
OLO2-40W2M1-30K7-24FL-1C20P-1_GY-A2	> 5.400	> 135
OLO2-50W2M1-30K7-24FL-1C20P-1_GY-A2	> 6.750	> 135
OLO2-60W2M1-30K7-24FL-1C20P-1_GY-A2	> 8.100	> 135
OLO2-80W2M1-30K7-24FL-1C20P-1_GY-A2	> 10.000	> 125
OLO2-100W2M1-30K7-24FL-1C20P-1_GY-A2	> 12.000	> 120

References	4.000K	
	Lumens	LPW
OLO2-25W2M1-40K7-24FL-1C20P-1_GY-A2	> 3.625	> 145
OLO2-40W2M1-40K7-24FL-1C20P-1_GY-A2	> 5.800	> 145
OLO2-50W2M1-40K7-24FL-1C20P-1_GY-A2	> 7.250	> 145
OLO2-60W2M1-40K7-24FL-1C20P-1_GY-A2	> 8.700	> 145
OLO2-80W2M1-40K7-24FL-1C20P-1_GY-A2	> 10.800	> 135
OLO2-100W2M1-40K7-24FL-1C20P-1_GY-A2	> 13.000	> 130

NOTE: The luminous flux values may vary depending on the selected luminaire configuration due to the different electrical insulation options, available optics, and the colourimetric and binning parameters of the LED diode.



PUBLIC LIGHTING

ESTRADA Series - Retrofit

ESTRADA Series



Features

- Aluminium sheet with stainless steel screws
- Configuration: 3000K 70CRI (other configurations available on request)
- Luminous flux maintenance L90 > 100,000 hours
- Different photometric distributions depending on the application
- DALI-2 dimmable driver, adjustable via NFC
- Programmable at fixed power or by power step dimming
- Programmable from the control cabinet (optional)
- Individual surge protection device 20 kV

Dimensions

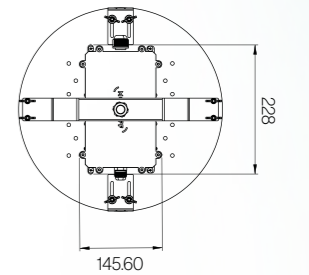
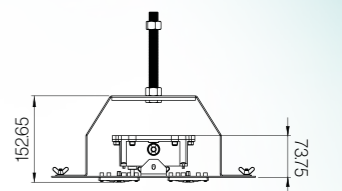
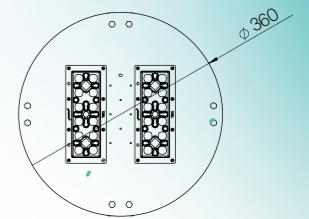
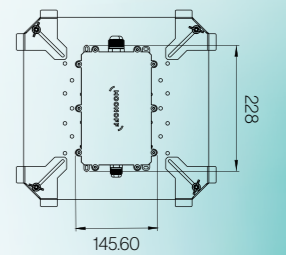
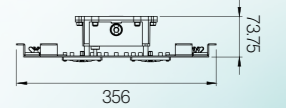
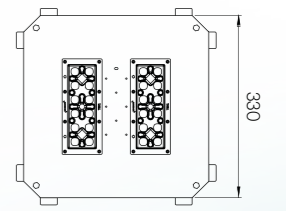

Photometric curves

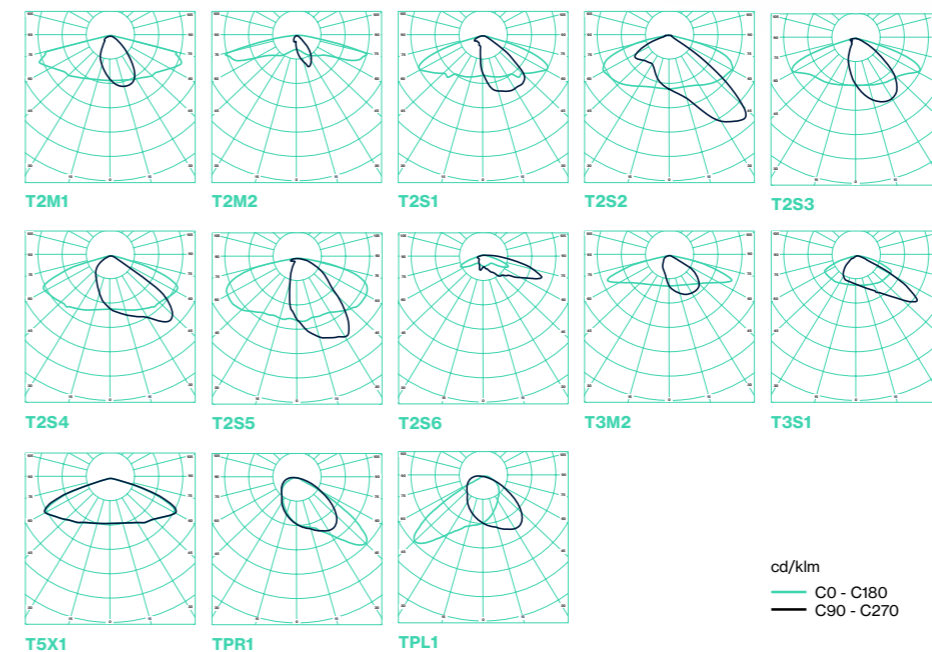

Installation on fernandina-style luminaire



Circular installation



Square installation



Installation on villa-style luminaire

The **ESTRADA Series** Series module represents a significant step forward in luminaire modernisation, thanks to its efficient design and the technical features it incorporates. Its flexible architecture, based on standardised components, ensures a long service life and facilitates future upgrades.

With a maximum power of 100 W, ESTRADA Series stands out as a next-generation retrofit solution that simplifies installation processes, transforming conventional luminaires into sustainable and efficient systems.





Reference configurator

Model	Power	Optics	CCT	CRI	Driver	Elements	SPD	EL. class	RAL color	Treatment	
EST1 Series 1	25W	2M1 Medium T.II	22K 2.200K	7 70	24DI 220-240 VAC Prog. DALI-2, D4I	1C Square laminar structure	20P 20kV	1 Class I	BK RAL 9005 black	A2 250 hrs AISI 304	
	40W	2M2 Medium T.II	27K 2.700K	8 80	24T2 220-240 VAC Prog. DALI-2	1D Circular laminar structure	20C 20kV	2 Class II	** On request	A4 250 hrs AISI 316	
	50W	2S1 Short T.II	30K 3.000K							B2 500 hrs AISI 304	
	60W	2S2 Short T.II	40K 4.000K							B4 500 hrs AISI 316	
	80W	2S3 Short T.II								C2 1000 hrs AISI 304	
	100W	2S4 Short T.II									C4 1000 hrs AISI 316
		2S5 Short T.II									D2 1500 hrs AISI 304
		2S6 Short T.II									D4 1500 hrs AISI 316
		3M2 Medium T.III									** On request
		3S1 Short T.III									
	5X1 Symmetric TV										
	PR1 Right pedestrian										
	PL1 Left pedestrian										

References	3.000K	
	Lumens	LPW
EST1-25W2M1-30K7-24DI-1C20P-1_BK-A2	> 3250	> 130
EST1-40W2M1-30K7-24DI-1C20P-1_BK-A2	> 5200	> 130
EST1-50W2M1-30K7-24DI-1C20P-1_BK-A2	> 6500	> 130
EST1-60W2M1-30K7-24DI-1C20P-1_BK-A2	> 7800	> 130
EST1-80W2M1-30K7-24DI-1C20P-1_BK-A2	> 10400	> 130
EST1-100W2M1-30K7-24DI-1C20P-1_BK-A2	> 13000	> 130

References	4.000K	
	Lumens	LPW
EST1-25W2M1-40K7-24DI-1C20P-1_BK-A2	> 3375	> 135
EST1-40W2M1-40K7-24DI-1C20P-1_BK-A2	> 5400	> 135
EST1-50W2M1-40K7-24DI-1C20P-1_BK-A2	> 6750	> 135
EST1-60W2M1-40K7-24DI-1C20P-1_BK-A2	> 8100	> 135
EST1-80W2M1-40K7-24DI-1C20P-1_BK-A2	> 10800	> 135
EST1-100W2M1-40K7-24DI-1C20P-1_BK-A2	> 13500	> 135

NOTE: The luminous flux values may vary depending on the selected luminaire configuration due to the different electrical insulation options, available optics, and the colourimetric and binning parameters of the LED diode.



Project: Villanueva de Alcardete
Location: Toledo, Castilla la Mancha
Luminaire: ESTRADA Series



PUBLIC LIGHTING

TESLA Series PRO - Street light

TESLA

Series PRO

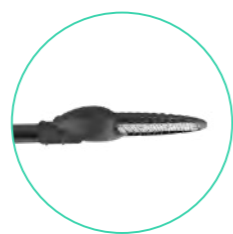

Installation on pole



Installation on column

Modern LED public lighting luminaire, lightweight and compact, with high efficiency to provide efficient lighting suitable for rural and urban environments.

TESLA Series PRO features an innovative design that brings together all the technology developed by Moonoff to offer customers a reliable, high-quality option.

Available in different power ratings optimised to meet the actual requirements of the road or project to be illuminated.



Features

- Die-cast aluminium body with stainless steel screws
- Tilt adjustment possible $-5^\circ / +10^\circ$
- Configuration: 3000K 70CRI (other configurations available on request)
- Luminous flux maintenance L90 > 100,000 hours
- Different photometric distributions depending on the application
- 0-10 V/PWM and DALI-2 dimmable driver, adjustable via NFC
- Programmable at fixed power or by power step dimming
- Programmable from the control cabinet (optional)
- Individual surge protection device 10 kV or 20 kV
- Possibility of use with NEMA or ZHAGA socket

Dimensions

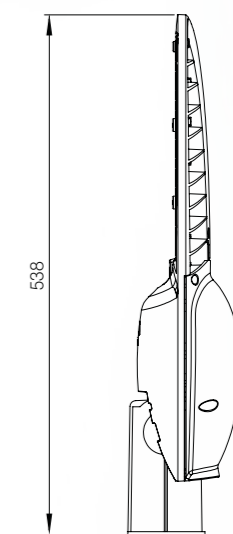
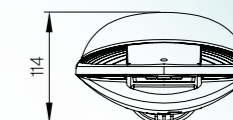
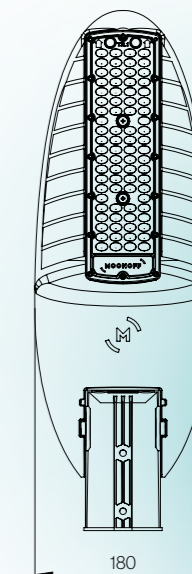
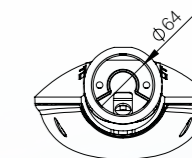

Photometric curves

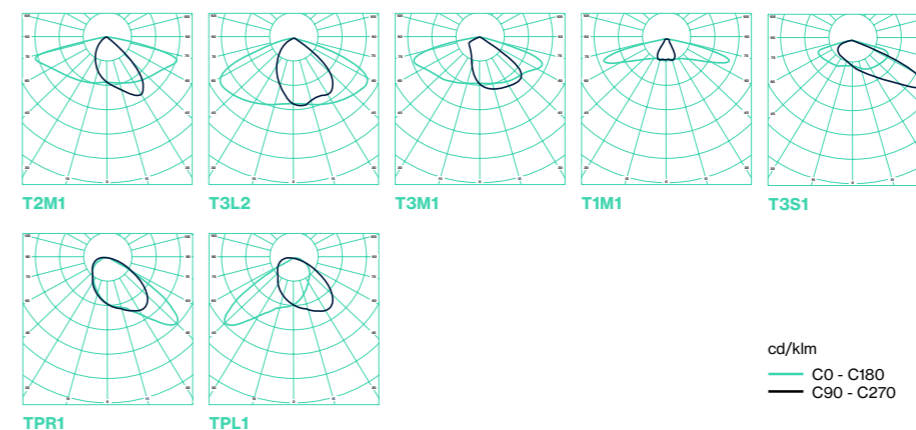

Reference configurator

Model	Power	Optics	CCT	CRI	Driver	Elements	SPD	EL. class	RAL color	Treatment
TSP1 Series 1	30W	2M1 Medium T.II	22K 2.200K	7 70	27PR 100-277 VAC Prog. Reg. O-10V, PWM	CL Smooth cover	10S 10kV	1 Class I	GY RAL 7010 grey	A2 250 hrs AISI 304
	40W¹	3L2 Long T.III	27K 2.700K	8 80		24T1 220-240 VAC Prog. DALI-2, ZH/24V				CS IP cover lid
	60W	3M1 Medium T.III	30K 3.000K		24T2 220-240 VAC Prog. DALI-2	ZS Upper Zhaga socket				B2 500 hrs AISI 304
	65W¹	1M1 Medium T.I	40K 4.000K			S3 3-pin NEMA socket				B4 500 hrs AISI 316
	80W	3S1 Short T.III				S5 5-pin NEMA socket				C2 1000 hrs AISI 304
			PR1 Right pedestrian				S7 7-pin NEMA socket			C4 1000 hrs AISI 316
			PL1 Left pedestrian						D2 1500 hrs AISI 304	
										D4 1500 hrs AISI 316
										** On request

¹Power available for the 24T1 and 24T2 drivers

References	3.000K	
	Lumens	LPW
TSP1-30W2M1-30K7-27PR-CL10S-1_GY-A2	> 3.990	> 133
TSP1-40W2M1-30K7-24T1-CL10S-1_GY_A2	> 5.200	> 130
TSP1-60W2M1-30K7-27PR-CL10S-1_GY-A2	> 7.500	> 125
TSP1-65W2M1-30K7-24T1-CL10S-1_GY_A2	> 7.800	> 120
TSP1-80W2M1-30K7-27PR-CL10S-1_GY-A2	> 8.960	> 112

References	4.000K	
	Lumens	LPW
TSP1-30W2M1-40K7-27PR-CL10S-1_GY-A2	> 4.290	> 143
TSP1-40W2M1-40K7-24T1-CL10S-1_GY_A2	> 5.600	> 140
TSP1-60W2M1-40K7-27PR-CL10S-1_GY-A2	> 8.100	> 135
TSP1-65W2M1-40K7-24T1-CL10S-1_GY_A2	> 8.450	> 130
TSP1-80W2M1-40K7-27PR-CL10S-1_GY-A2	> 9.840	> 123

NOTE: The luminous flux values may vary depending on the selected luminaire configuration due to the different electrical insulation options, available optics, and the colourimetric and binning parameters of the LED diode.

Reference configurator

Model	Power	Optics	CCT	CRI	Driver	Elements	SPD	EL. class	RAL color	Treatment	
TSP2 Series 2	25W	2M1 Medium T.II	22K 2.200K	7 70	24DI 220-240 VAC Prog. DALI-2, D4i	CL Smooth cover	20C 20kV	1 Class I	GY RAL 7010 grey	A2 250 hrs AISI 304	
	45W	3L2 Long T.III	27K 2.700K	8 80		24FL 220-240 VAC Prog. DALI-2, ZH/24V				CS IP cover lid	2 Class II
	65W	3M1 Medium T.III	30K 3.000K		24T2 220-240 VAC Prog. DALI-2	ZS Upper Zhaga socket				B2 500 hrs AISI 304	
	85W	1M1 Medium T.I	40K 4.000K			S3 3-pin NEMA socket				B4 500 hrs AISI 316	
				3S1 Short T.III			S5 5-pin NEMA socket		C2 1000 hrs AISI 304		
				PR1 Right pedestrian			S7 7-pin NEMA socket		C4 1000 hrs AISI 316		
										D2 1500 hrs AISI 304	
											D4 1500 hrs AISI 316
											** On request

References	3.000K	
	Lumens	LPW
TSP2-25W2M1-30K7-24FL-CL20C-1_GY-A2	> 3.900	> 156
TSP2-45W2M1-30K7-24FL-CL20C-1_GY-A2	> 6.885	> 153
TSP2-65W2M1-30K7-24FL-CL20C-1_GY-A2	> 9.750	> 150
TSP2-85W2M1-30K7-24FL-CL20C-1_GY-A2	> 12.325	> 145

References	4.000K	
	Lumens	LPW
TSP2-25W2M1-40K7-24FL-CL20C-1_GY-A2	> 4.075	> 163
TSP2-45W2M1-40K7-24FL-CL20C-1_GY-A2	> 7.200	> 160
TSP2-65W2M1-40K7-24FL-CL20C-1_GY-A2	> 10.205	> 157
TSP2-85W2M1-40K7-24FL-CL20C-1_GY-A2	> 12.920	> 152

NOTE: The luminous flux values may vary depending on the selected luminaire configuration due to the different electrical insulation options, available optics, and the colourimetric and binning parameters of the LED diode.



TESLA

Series MAX



Installation on pole



Installation on column

Modern LED public lighting luminaire, lightweight and compact, with high efficiency to provide efficient lighting suitable for rural and urban environments.

TESLA Series MAX features an innovative design that brings together all the technology developed by Moonoff to offer customers a reliable, high-quality option.

It is the best solution for reducing the payback period of a project investment, delivering a much faster return than other options on the market. Available in different power ratings optimised to meet the actual requirements of the road or project to be illuminated.



Features

- Die-cast aluminium body with stainless steel screws
- Tilt adjustment possible -5° / +15°
- Configuration: 3000K 70CRI (other configurations available on request)
- Luminous flux maintenance L90 > 100,000 hours
- Different photometric distributions depending on the application
- 0-10 V/PWM and DALI-2 dimmable driver, adjustable via NFC
- Programmable at fixed power or by power step dimming
- Programmable from the control cabinet (optional)
- Individual surge protection device 10 kV or 20 kV
- Possibility of use with NEMA or ZHAGA socket

Dimensions

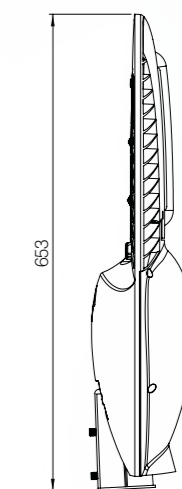
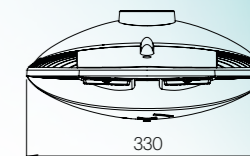
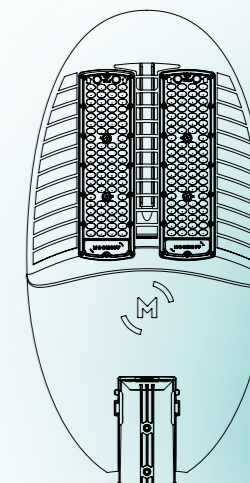
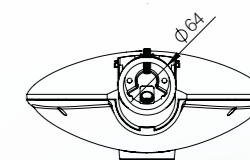

Photometric curves

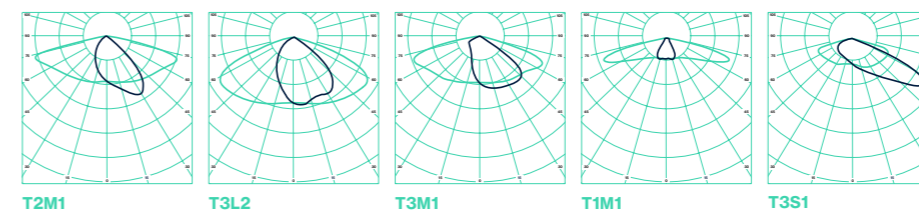

cd/klm
— C0 - C180
— C90 - C270

Reference configurator

Model	Power	Optics	CCT	CRI	Driver	Elements	SPD	EL. class	RAL color	Treatment
TSM1 Series 1	120W	2M1 Medium T.II	22K 2.200K	7 70	27PR 100-277 VAC Prog. Reg. O-10V, PWM	CS IP cover lid	10S 10kV	1 Class I	GY RAL 7010 grey	A2 250 hrs AISI 304
	130W ¹	3L2 Long T.III	27K 2.700K	8 80	24T1 220-240 VAC Prog. DALI-2, ZH/24V	ZS Upper Zhaga socket		2 Class II	** On request	A4 250 hrs AISI 316
	160W	3M1 Medium T.III	30K 3.000K	24T2 220-240 VAC Prog. DALI-2	S3 3-pin NEMA socket	B2 500 hrs AISI 304				
		1M1 Medium T.I	40K 4.000K	S5 5-pin NEMA socket	B4 500 hrs AISI 316					
		3S1 Short T.III	S7 7-pin NEMA socket	C2 1000 hrs AISI 304						
		C4 1000 hrs AISI 316								
	D2 1500 hrs AISI 304									
	D4 1500 hrs AISI 316									
	** On request									

¹Power available for the 24T1 and 24T2 drivers

References	3.000K	
	Lumens	LPW
TSM1-120W2M1-30K7-27PR-CS10S-1_GY-A2	> 14.800	> 124
TSM1-130W2M1-30K7-24T1-CS10S-1_GY_A2	> 15.600	> 120
TSM1-160W2M1-30K7-27PR-CS10S-1_GY-A2	> 18.000	> 112

References	4.000K	
	Lumens	LPW
TSM1-120W2M1-40K7-27PR-CS10S-1_GY-A2	> 16.000	> 133
TSM1-130W2M1-40K7-24T1-CS10S-1_GY_A2	> 16.900	> 130
TSM1-160W2M1-40K7-27PR-CS10S-1_GY-A2	> 19.600	> 122

NOTE: The luminous flux values may vary depending on the selected luminaire configuration due to the different electrical insulation options, available optics, and the colourimetric and binning parameters of the LED diode.

Reference configurator

Model	Power	Optics	CCT	CRI	Driver	Elements	SPD	EL. class	RAL color	Treatment
TSM2 Series 2	125W	2M1 Medium T.II	22K 2.200K	7 70	24DI 220-240 VAC Prog. DALI-2, D4i	CS IP cover lid	20P 20kV	1 Class I	GY RAL 7010 grey	A2 250 hrs AISI 304
	165W	3L2 Long T.III	27K 2.700K	8 80	24FL 220-240 VAC Prog. DALI-2, ZH/24V	ZS Upper Zhaga socket	20C 20kV	2 Class II	** On request	A4 250 hrs AISI 316
		3M1 Medium T.III	30K 3.000K	24T2 220-240 VAC Prog. DALI-2	S3 3-pin NEMA socket	B2 500 hrs AISI 304				
		1M1 Medium T.I	40K 4.000K	S5 5-pin NEMA socket	B4 500 hrs AISI 316					
		3S1 Short T.III	S7 7-pin NEMA socket	C2 1000 hrs AISI 304						
		C4 1000 hrs AISI 316								
D2 1500 hrs AISI 304										
D4 1500 hrs AISI 316										
** On request										

References	3.000K	
	Lumens	LPW
TSM2-125W2M1-30K7-24FL-CS20C-1_GY-A2	> 18.750	> 150
TSM2-165W2M1-30K7-24FL-CS20C-1_GY-A2	> 23.925	> 145

References	4.000K	
	Lumens	LPW
TSM2-125W2M1-40K7-24FL-CS20C-1_GY-A2	> 19.625	> 157
TSM2-165W2M1-40K7-24FL-CS20C-1_GY-A2	> 25.080	> 152

NOTE: The luminous flux values may vary depending on the selected luminaire configuration due to the different electrical insulation options, available optics, and the colourimetric and binning parameters of the LED diode.



PUBLIC LIGHTING

STELLA Series H S2 - Garden light

STELLA

Series H S2



Installation on pole



Installation on column

The **STELLA Series H S2** LED luminaire by Moonoff stands out for its elegant and carefully designed appearance, ideal for lighting urban and residential streets, as well as parks and green areas. Its aesthetics make it the perfect choice for historic centres, parks, squares or any road where a balance between functionality and beauty is sought.

Moonoff's latest-generation LED technology, integrated into the STELLA Series H S2, offers high luminous performance and low energy consumption. In addition, its versatility and adaptability make it an ideal solution for smart cities, enabling remote management and control of public lighting.



Features

- Die-cast aluminium body with stainless steel screws
- Configuration: 3000K 70CRI (other configurations available on request)
- Luminous flux maintenance L90 > 100,000 hours
- Different photometric distributions depending on the application
- DALI-2 dimmable driver, adjustable via NFC
- Programmable at fixed power or by power step dimming
- Programmable from the control cabinet (optional)
- Individual surge protection device 20 kV
- Possibility of use with NEMA or ZHAGA socket (lower/upper)
- Tool-free opening

Dimensions

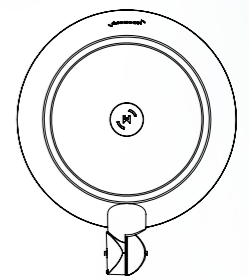
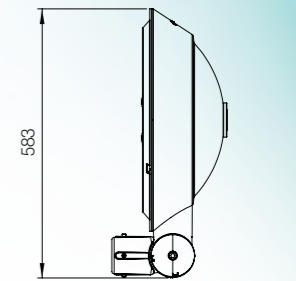
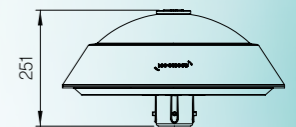
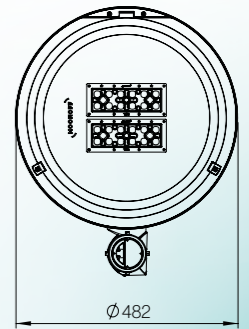
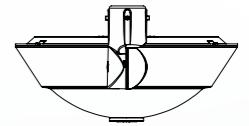

Photometric curves

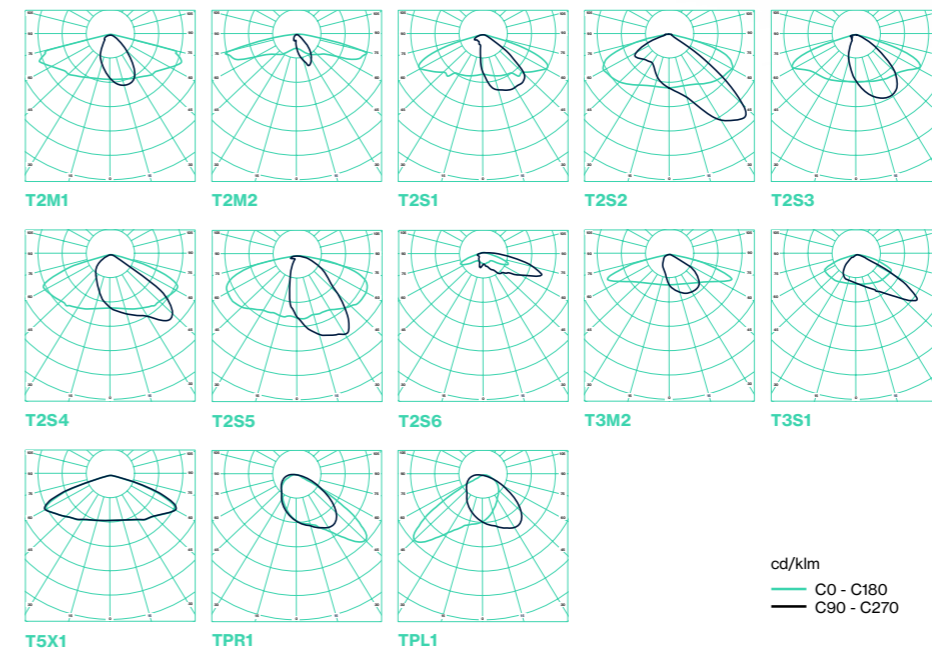



Reference configurator

Model	Power	Optics	CCT	CRI	Driver	Elements	SPD	EL. class	RAL color	Treatment	
STH2 Series 2	25W	2M1 Medium T.II	22K 2.200K	7 70	24FL 220-240 VAC Prog. DALI-2, ZH/24V	gg	20P 20kV	1 Class I	BK RAL 9005 black	A2 250 hrs AISI 304	
	40W	2M2 Medium T.II	27K 2.700K	8 80	24T1 220-240 VAC Prog. DALI-2, ZH/24V	CS IP cover lid	20C 20kV	2 Class II	** On request	A4 250 hrs AISI 316	
	55W	2S1 Short T.II	30K 3.000K		24T2 220-240 VAC Prog. DALI-2	ZS Upper Zhaga socket				B2 500 hrs AISI 304	
	75W	2S2 Short T.II	40K 4.000K			ZI Lower Zhaga socket				B4 500 hrs AISI 316	
	100W	2S3 Short T.II				Z2 Upper Zhaga socket + lower					C2 1000 hrs AISI 304
			2S4 Short T.II			NZ Upper NEMA socket + lower Zhaga					C4 1000 hrs AISI 316
			2S5 Short T.II			S3 3-pin NEMA socket					D2 1500 hrs AISI 304
			2S6 Short T.II			S5 5-pin NEMA socket					D4 1500 hrs AISI 316
			3M2 Medium T.III			S7 7-pin NEMA socket				** On request	
			3S1 Short T.III								
5X1 Symmetric TV											
PR1 Right pedestrian											
PL1 Left pedestrian											

References	3.000K	
	Lumens	LPW
STH2-25W2M1-30K7-24FL-gg20P-1_BK-A2	> 3.500	> 140
STH2-40W2M1-30K7-24FL-gg20P-1_BK-A2	> 5.600	> 140
STH2-55W2M1-30K7-24FL-gg20P-1_BK-A2	> 7.700	> 140
STH2-75W2M1-30K7-24FL-gg20P-1_BK-A2	> 10.500	> 140
STH2-100W2M1-30K7-24FL-gg20P-1_BK-A2	> 14.000	> 140

References	4.000K	
	Lumens	LPW
STH2-25W2M1-40K7-24FL-gg20P-1_BK-A2	> 3.750	> 150
STH2-40W2M1-40K7-24FL-gg20P-1_BK-A2	> 6.000	> 150
STH2-55W2M1-40K7-24FL-gg20P-1_BK-A2	> 8.250	> 150
STH2-75W2M1-40K7-24FL-gg20P-1_BK-A2	> 11.250	> 150
STH2-100W2M1-40K7-24FL-gg20P-1_BK-A2	> 15.000	> 150

NOTE: The luminous flux values may vary depending on the selected luminaire configuration due to the different electrical insulation options, available optics, and the colourimetric and binning parameters of the LED diode.





PUBLIC LIGHTING

STELLA Series V S2 - Garden light

STELLA

Series V S2



Installation on column

The **STELLA Series V S2** LED luminaire by Moonoff stands out for its elegant and carefully designed appearance, ideal for lighting urban and residential streets, as well as parks and green areas. Its aesthetics make it the perfect choice for historic centres, parks, squares or any road where a balance between functionality and beauty is sought.

Moonoff's latest-generation LED technology, integrated into the **STELLA Series V S2**, offers high luminous performance and low energy consumption. In addition, its versatility and adaptability make it an ideal solution for smart cities, enabling remote management and control of public lighting.



Features

- Die-cast aluminium body with stainless steel screws
- Configuration: 3000K 70CRI (other configurations available on request)
- Luminous flux maintenance L90 > 100,000 hours
- Different photometric distributions depending on the application
- DALI-2 dimmable driver, adjustable via NFC
- Programmable at fixed power or by power step dimming
- Programmable from the control cabinet (optional)
- Individual surge protection device 20 kV
- Possibility of use with NEMA or ZHAGA socket (lower/upper)
- Tool-free opening

Dimensions

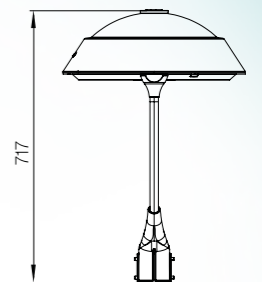
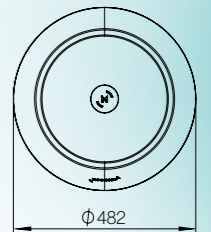
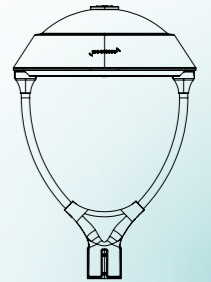
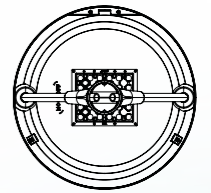

Photometric curves

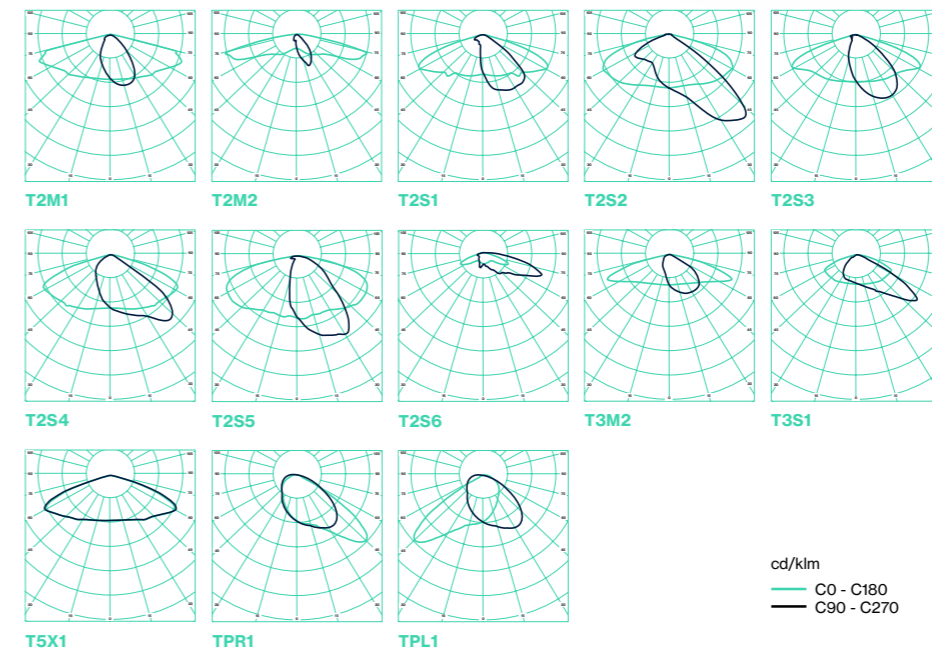



Reference configurator

Model	Power	Optics	CCT	CRI	Driver	Elements	SPD	EL. class	RAL color	Treatment
STV2 Series 2	25W	2M1 Medium T.II	22K 2.200K	7 70	24FL 220-240 VAC Prog. DALI-2, ZH/24V	gg	20P 20kV	1 Class I	BK RAL 9005 black	A2 250 hrs AISI 304
	40W	2M2 Medium T.II	27K 2.700K	8 80	24T1 220-240 VAC Prog. DALI-2, ZH/24V	CS IP cover lid	20C 20kV	2 Class II	** On request	A4 250 hrs AISI 316
	55W	2S1 Short T.II	30K 3.000K		24T2 220-240 VAC Prog. DALI-2	ZS Upper Zhaga socket				B2 500 hrs AISI 304
	75W	2S2 Short T.II	40K 4.000K			ZI Lower Zhaga socket				B4 500 hrs AISI 316
	100W	2S3 Short T.II				Z2 Upper Zhaga socket + lower	C2 1000 hrs AISI 304			
						NZ Upper NEMA socket + lower Zhaga	C4 1000 hrs AISI 316			
						S3 3-pin NEMA socket	D2 1500 hrs AISI 304			
						S5 5-pin NEMA socket	D4 1500 hrs AISI 316			
						S7 7-pin NEMA socket	** On request			
						2S4 Short T.II				
						2S5 Short T.II				
	2S6 Short T.II									
	3M2 Medium T.III									
	3S1 Short T.III									
5X1 Symmetric TV										
PR1 Right pedestrian										
PL1 Left pedestrian										

References	3.000K	
	Lumens	LPW
STV2-25W2M1-30K7-24FL-gg20P-1_BK-A2	> 3.500	> 140
STV2-40W2M1-30K7-24FL-gg20P-1_BK-A2	> 5.600	> 140
STV2-55W2M1-30K7-24FL-gg20P-1_BK-A2	> 7.700	> 140
STV2-75W2M1-30K7-24FL-gg20P-1_BK-A2	> 10.500	> 140
STV2-100W2M1-30K7-24FL-gg20P-1_BK-A2	> 14.000	> 140

References	4.000K	
	Lumens	LPW
STV2-25W2M1-40K7-24FL-gg20P-1_BK-A2	> 3.750	> 150
STV2-40W2M1-40K7-24FL-gg20P-1_BK-A2	> 6.000	> 150
STV2-55W2M1-40K7-24FL-gg20P-1_BK-A2	> 8.250	> 150
STV2-75W2M1-40K7-24FL-gg20P-1_BK-A2	> 11.250	> 150
STV2-100W2M1-40K7-24FL-gg20P-1_BK-A2	> 15.000	> 150

*The lighting data shown in the tables refer to the light source.

NOTE: The luminous flux values may vary depending on the selected luminaire configuration due to the different electrical insulation options, available optics, and the colourimetric and binning parameters of the LED diode.





FARO Series



Wall-mounted bracket installation



Installation on column

LED public lighting luminaire with a classic, stylised design reminiscent of circular lantern-style luminaires (Fernandina).

FARO Series enables LED lighting to be integrated into historic city centres without causing any visual impact, while preserving the aesthetics of the heritage environment.

The design of the FARO Series luminaire is also ideal for lighting parks, squares or any road lit by lantern-style luminaires installed on columns or wall-mounted brackets on façades.



Features

- Die-cast aluminium body with stainless steel screws
- Installation using 3/4" GAS fitting (optional accessory for mounting on Ø 60 mm column)
- Configuration: 3000K 70CRI (other configurations available on request)
- Luminous flux maintenance L90 > 100,000 hours
- Different photometric distributions depending on the application
- DALI-2 dimmable driver, adjustable via NFC
- Programmable at fixed power or by power step dimming
- Programmable from the control cabinet (optional)
- Individual surge protection device 20 kV
- Possibility of use with NEMA or ZHAGA socket (lower/upper)

Dimensions

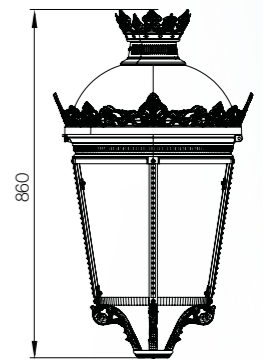
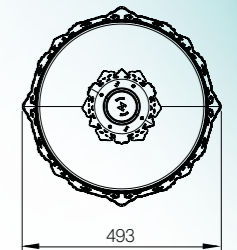
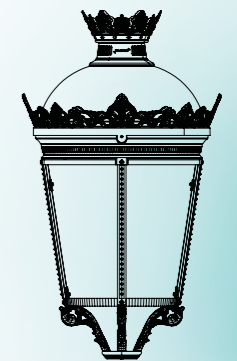
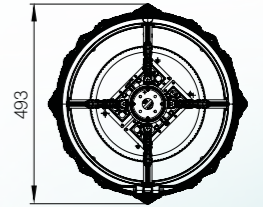

Photometric curves

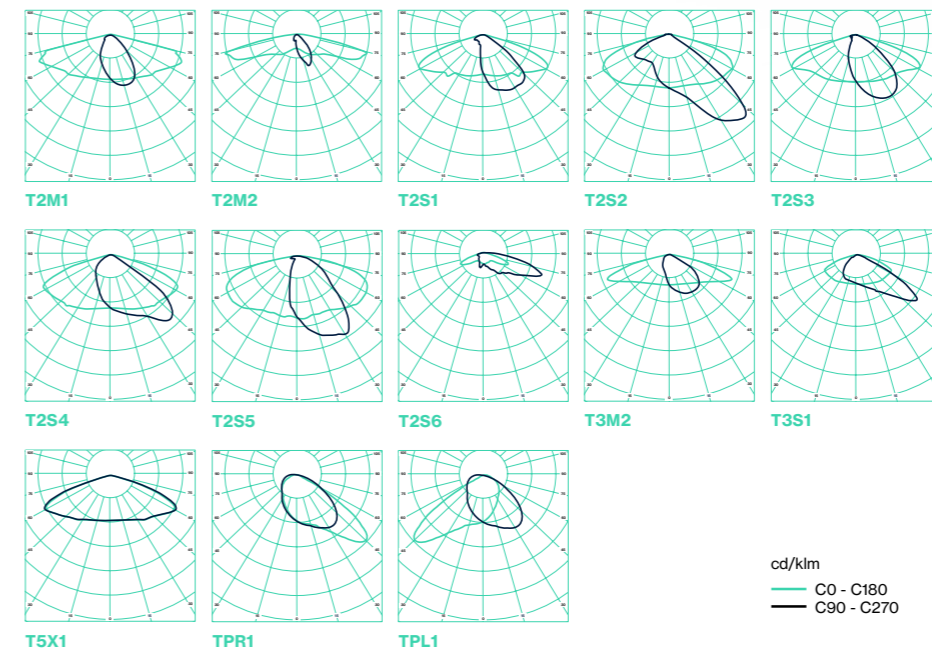

Reference configurator

Model	Power	Optics	CCT	CRI	Driver	Elements	SPD	EL. class	RAL color	Treatment
FRO2 Series 2	25W	2M1 Medium T.II	22K 2.200K	7 70	24FL 220-240 VAC Prog. DALI-2, ZH/24V	gg	20P 20kV	1 Class I	BK RAL 9005 black	A2 250 hrs AISI 304
	40W	2M2 Medium T.II	27K 2.700K	8 80	24T1 220-240 VAC Prog. DALI-2, ZH/24V	CS IP cover lid	20C 20kV	2 Class II	** On request	A4 250 hrs AISI 316
	55W	2S1 Short T.II	30K 3.000K		24T2 220-240 VAC Prog. DALI-2	ZS Upper Zhaga socket				B2 500 hrs AISI 304
	75W ¹	2S2 Short T.II	40K 4.000K			ZI Lower Zhaga socket				B4 500 hrs AISI 316
	100W	2S3 Short T.II				Z2 Upper Zhaga socket + lower				C2 1000 hrs AISI 304
			2S4 Short T.II			NZ Upper NEMA socket + lower Zhaga				C4 1000 hrs AISI 316
			2S5 Short T.II			S3 3-pin NEMA socket				D2 1500 hrs AISI 304
			2S6 Short T.II			S5 5-pin NEMA socket				D4 1500 hrs AISI 316
			3M2 Medium T.III			S7 7-pin NEMA socket				** On request
			3S1 Short T.III							
			5X1 Symmetric TV							
	PR1 Right pedestrian									
	PL1 Left pedestrian									

¹ Maximum power available for the 24T1 driver

References	3.000K	
	Lumens	LPW
FRO2-25W2M1-30K7-24FL-CS20P-1_BK-A2	> 3.500	> 140
FRO2-40W2M1-30K7-24FL-CS20P-1_BK-A2	> 5.600	> 140
FRO2-55W2M1-30K7-24FL-CS20P-1_BK-A2	> 7.700	> 140
FRO2-75W2M1-30K7-24FL-CS20P-1_BK-A2	> 10.500	> 140
FRO2-100W2M1-30K7-24FL-CS20P-1_BK-A2	> 14.000	> 140

References	4.000K	
	Lumens	LPW
FRO2-25W2M1-40K7-24FL-CS20P-1_BK-A2	> 3.750	> 150
FRO2-40W2M1-40K7-24FL-CS20P-1_BK-A2	> 6.000	> 150
FRO2-55W2M1-40K7-24FL-CS20P-1_BK-A2	> 8.250	> 150
FRO2-75W2M1-40K7-24FL-CS20P-1_BK-A2	> 11.250	> 150
FRO2-100W2M1-40K7-24FL-CS20P-1_BK-A2	> 15.000	> 150

*The lighting data shown in the tables refer to the light source.

NOTE: The luminous flux values may vary depending on the selected luminaire configuration due to the different electrical insulation options, available optics, and the colourimetric and binning parameters of the LED diode.

Reference configurator

Model	Power	Optics	CCT	CRI	Driver	Elements	SPD	EL. class	RAL color	Treatment	
FRO3 Serie 3	25W	2M1 Medium T.II	22K 2.200K	7 70	24DI 220-240 VAC Prog. DALI-2, D4I	gg	20P 20kV	1 Class I	BK RAL 9005 black	A2 250 hrs AISI 304	
	40W	2M2 Medium T.II	27K 2.700K	8 80	24FL 220-240 VAC Prog. DALI-2, ZH/24V	CS IP cover lid	20C 20kV	2 Class II	** On request	A4 250 hrs AISI 316	
	50W	2S1 Short T.II	30K 3.000K		24T2 220-240 VAC Prog. DALI-2	ZS Upper Zhaga socket				B2 500 hrs AISI 304	
	60W	2S2 Short T.II	40K 4.000K			ZI Lower Zhaga socket				B4 500 hrs AISI 316	
	80W	2S3 Short T.II				Z2 Upper Zhaga socket + lower				C2 1000 hrs AISI 304	
	100W	2S4 Short T.II				NZ Upper NEMA socket + lower Zhaga					C4 1000 hrs AISI 316
			2S5 Short T.II			S3 3-pin NEMA socket				D2 1500 hrs AISI 304	
			2S6 Short T.II			S5 5-pin NEMA socket				D4 1500 hrs AISI 316	
			3M2 Medium T.III			S7 7-pin NEMA socket				** On request	
			3S1 Short T.III								
			5X1 Symmetric TV								
			PR1 Right pedestrian								
	PL1 Left pedestrian										

References	3.000K	
	Lumens	LPW
FRO3-25W2M1-30K7-24FL-CS20P-1_BK-A2	> 3.375	> 135
FRO3-40W2M1-30K7-24FL-CS20P-1_BK-A2	> 5.400	> 135
FRO3-50W2M1-30K7-24FL-CS20P-1_BK-A2	> 6.750	> 135
FRO3-60W2M1-30K7-24FL-CS20P-1_BK-A2	> 8.100	> 135
FRO3-80W2M1-30K7-24FL-CS20P-1_BK-A2	> 10.000	> 125
FRO3-100W2M1-30K7-24FL-CS20P-1_BK-A2	> 12.000	> 120

References	4.000K	
	Lumens	LPW
FRO3-25W2M1-40K7-24FL-CS20P-1_BK-A2	> 3.625	> 145
FRO3-40W2M1-40K7-24FL-CS20P-1_BK-A2	> 5.800	> 145
FRO3-50W2M1-40K7-24FL-CS20P-1_BK-A2	> 7.250	> 145
FRO3-60W2M1-40K7-24FL-CS20P-1_BK-A2	> 8.700	> 145
FRO3-80W2M1-40K7-24FL-CS20P-1_BK-A2	> 10.800	> 135
FRO3-100W2M1-40K7-24FL-CS20P-1_BK-A2	> 13.000	> 130

*The lighting data shown in the tables refer to the light source.

NOTE: The luminous flux values may vary depending on the selected luminaire configuration due to the different electrical insulation options, available optics, and the colourimetric and binning parameters of the LED diode.



ROYALTY Series



Wall-mounted bracket installation



Installation on column

LED public lighting luminaire with a classic, stylised design reminiscent of traditional lantern-style luminaires.

ROYALTY Series enables LED lighting to be integrated into historic city centres without causing any visual impact, while preserving the aesthetics of the heritage environment.

The design of the ROYALTY Series luminaire is also ideal for lighting parks, squares or any road lit by lantern-style luminaires installed on columns or wall-mounted brackets on façades.



Features

- Die-cast aluminium body with stainless steel screws
- Installation using 3/4" GAS fitting (optional accessory for mounting on Ø 60 mm column)
- Configuration: 3000K 70CRI (other configurations available on request)
- Luminous flux maintenance L90 > 100,000 hours
- Different photometric distributions depending on the application
- DALI-2 dimmable driver, adjustable via NFC
- Programmable at fixed power or by power step dimming
- Programmable from the control cabinet (optional)
- Individual surge protection device 20 kV
- Possibility of use with NEMA or ZHAGA socket (lower/upper)

Dimensions

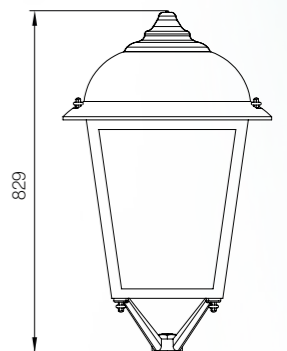
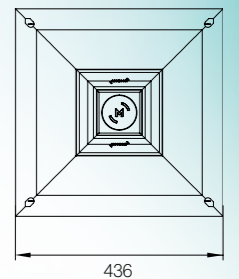
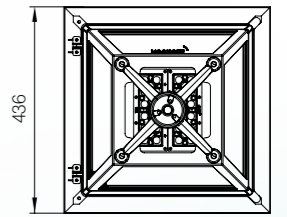

Photometric curves

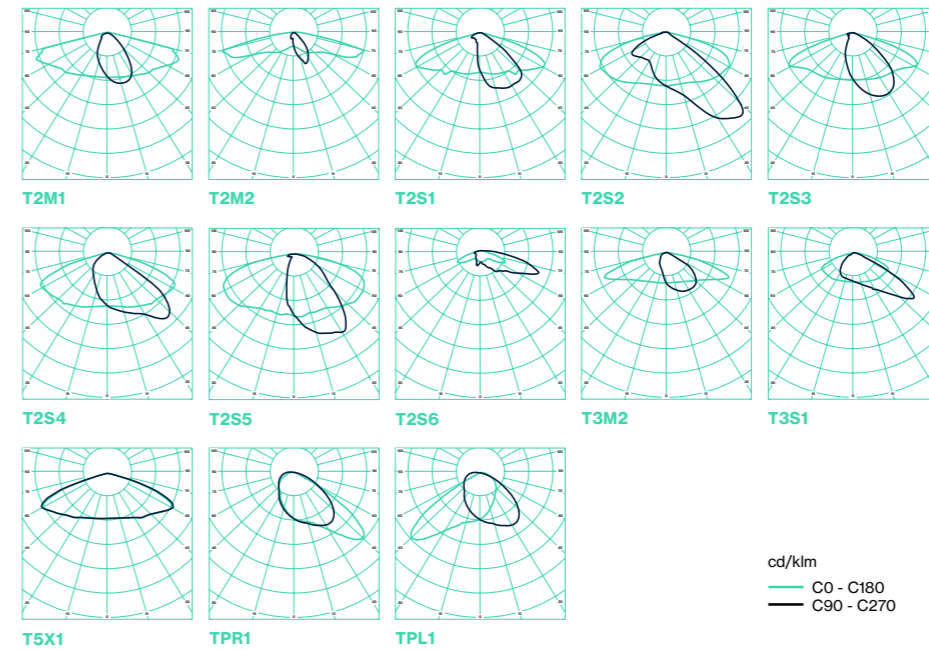

Reference configurator

Model	Power	Optics	CCT	CRI	Driver	Elements	SPD	EL. class	RAL color	Treatment	
RTY2 Series 2	25W	2M1 Medium T.II	22K 2.200K	7 70	24FL 220-240 VAC Prog. DALI-2, ZH/24V	gg	20P 20kV	1 Class I	BK RAL 9005 black	A2 250 hrs AISI 304	
	40W	2M2 Medium T.II	27K 2.700K	8 80	24T1 220-240 VAC Prog. DALI-2, ZH/24V	CS IP cover lid	20C 20kV	2 Class II	** On request	A4 250 hrs AISI 316	
	55W	2S1 Short T.II	30K 3.000K		24T2 220-240 VAC Prog. DALI-2	ZS Upper Zhaga socket				B2 500 hrs AISI 304	
	75W	2S2 Short T.II	40K 4.000K			ZI Lower Zhaga socket				B4 500 hrs AISI 316	
	100W	2S3 Short T.II				Z2 Upper Zhaga socket + lower					C2 1000 hrs AISI 304
		2S4 Short T.II				NZ Upper NEMA socket + lower Zhaga					C4 1000 hrs AISI 316
		2S5 Short T.II				S3 3-pin NEMA socket					D2 1500 hrs AISI 304
		2S6 Short T.II				S5 5-pin NEMA socket					D4 1500 hrs AISI 316
		3M2 Medium T.III				S7 7-pin NEMA socket					** On request
		3S1 Short T.III									
		5X1 Symmetric TV									
	PR1 Right pedestrian										
	PL1 Left pedestrian										

References	3.000K	
	Lumens	LPW
RTY2-25W2M1-30K7-24FL-CS20P-1_BK-A2	> 3.500	> 140
RTY2-40W2M1-30K7-24FL-CS20P-1_BK-A2	> 5.600	> 140
RTY2-55W2M1-30K7-24FL-CS20P-1_BK-A2	> 7.700	> 140
RTY2-75W2M1-30K7-24FL-CS20P-1_BK-A2	> 10.500	> 140
RTY2-100W2M1-30K7-24FL-CS20P-1_BK-A2	> 14.000	> 140

References	4.000K	
	Lumens	LPW
RTY2-25W2M1-40K7-24FL-CS20P-1_BK-A2	> 3.750	> 150
RTY2-40W2M1-40K7-24FL-CS20P-1_BK-A2	> 6.000	> 150
RTY2-55W2M1-40K7-24FL-CS20P-1_BK-A2	> 8.250	> 150
RTY2-75W2M1-40K7-24FL-CS20P-1_BK-A2	> 11.250	> 150
RTY2-100W2M1-40K7-24FL-CS20P-1_BK-A2	> 15.000	> 150

*The lighting data shown in the tables refer to the light source.

NOTE: The luminous flux values may vary depending on the selected luminaire configuration due to the different electrical insulation options, available optics, and the colourimetric and binning parameters of the LED diode.

Reference configurator

Model	Power	Optics	CCT	CRI	Driver	Elements	SPD	EL. class	RAL color	Treatment	
RTY3 Serie 3	25W	2M1 Medium T.II	22K 2.200K	7 70	24DI 220-240 VAC Prog. DALI-2, D4i	gg	20P 20kV	1 Class I	BK RAL 9005 black	A2 250 hrs AISI 304	
	40W	2M2 Medium T.II	27K 2.700K	8 80	24FL 220-240 VAC Prog. DALI-2, ZH/24V	CS IP cover lid	20C 20kV	2 Class II	** On request	A4 250 hrs AISI 316	
	50W	2S1 Short T.II	30K 3.000K		24T2 220-240 VAC Prog. DALI-2	ZS Upper Zhaga socket				B2 500 hrs AISI 304	
	60W	2S2 Short T.II	40K 4.000K			ZI Lower Zhaga socket				B4 500 hrs AISI 316	
	80W	2S3 Short T.II				Z2 Upper Zhaga socket + lower					C2 1000 hrs AISI 304
		2S4 Short T.II				NZ Upper NEMA socket + lower Zhaga					C4 1000 hrs AISI 316
		2S5 Short T.II				S3 3-pin NEMA socket					D2 1500 hrs AISI 304
		2S6 Short T.II				S5 5-pin NEMA socket					D4 1500 hrs AISI 316
		3M2 Medium T.III				S7 7-pin NEMA socket					** On request
		3S1 Short T.III									
		5X1 Symmetric TV									
	PR1 Right pedestrian										
	PL1 Left pedestrian										

References	3.000K	
	Lumens	LPW
RTY3-25W2M1-30K7-24FL-CS20P-1_BK-A2	> 3.375	> 135
RTY3-40W2M1-30K7-24FL-CS20P-1_BK-A2	> 5.400	> 135
RTY3-50W2M1-30K7-24FL-CS20P-1_BK-A2	> 6.750	> 135
RTY3-60W2M1-30K7-24FL-CS20P-1_BK-A2	> 8.100	> 135
RTY3-80W2M1-30K7-24FL-CS20P-1_BK-A2	> 10.000	> 125
RTY3-100W2M1-30K7-24FL-CS20P-1_BK-A2	> 12.000	> 120

References	4.000K	
	Lumens	LPW
RTY3-25W2M1-40K7-24FL-CS20P-1_BK-A2	> 3.625	> 145
RTY3-40W2M1-40K7-24FL-CS20P-1_BK-A2	> 5.800	> 145
RTY3-50W2M1-40K7-24FL-CS20P-1_BK-A2	> 7.250	> 145
RTY3-60W2M1-40K7-24FL-CS20P-1_BK-A2	> 8.700	> 145
RTY3-80W2M1-40K7-24FL-CS20P-1_BK-A2	> 10.800	> 135
RTY3-100W2M1-40K7-24FL-CS20P-1_BK-A2	> 13.000	> 130

*The lighting data shown in the tables refer to the light source.

NOTE: The luminous flux values may vary depending on the selected luminaire configuration due to the different electrical insulation options, available optics, and the colourimetric and binning parameters of the LED diode.



PUBLIC LIGHTING

FEDORA Series - Garden light

FEDORA

Series S2



Wall-mounted
bracket installation









Functional LED public lighting luminaire with a classic design for vertical suspended installation.

FEDORA Series, available in two power ratings, is an ideal luminaire for lighting different historic areas of cities, preserving the aesthetics without altering the heritage environment.

The design of the FEDORA luminaire integrates an optical solution that enables the use of different photometric distributions, as well as a wide range of colour temperatures depending on the area to be illuminated.



Features

-  Die-cast aluminium body with stainless steel screws
-  Installation using 3/4" GAS fitting
-  Configuration: 3000K 70CRI (other configurations available on request)
-  Luminous flux maintenance L90 > 100,000 hours
-  Different photometric distributions depending on the application
-  DALI-2 dimmable driver, adjustable via NFC
-  Programmable at fixed power or by power step dimming
-  Programmable from the control cabinet (optional)
-  Individual surge protection device 20 kV
-  Possibility of use with ZHAGA socket (lower)

Dimensions

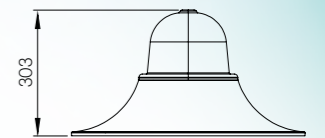
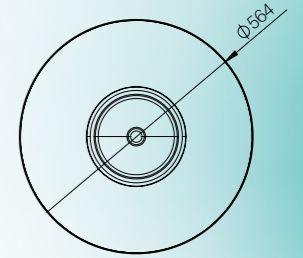
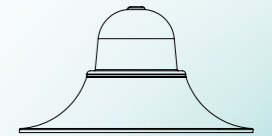
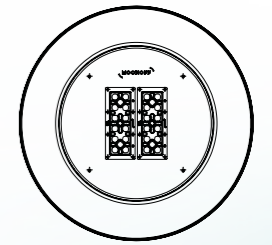

Photometric curves

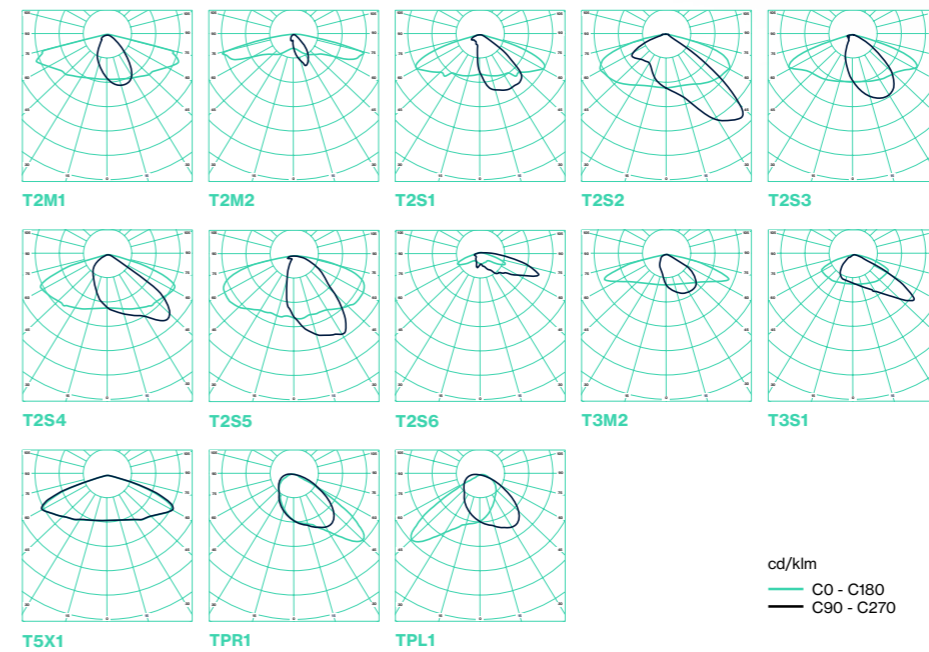



Reference configurator

Model	Power	Optics	CCT	CRI	Driver	Elements	SPD	EL. class	RAL color	Treatment
FDA2 Series 2	25W	2M1 Medium T.II	22K 2.200K	7 70	24FL 220-240 VAC Prog. DALI-2, ZH/24V	gg	20P 20kV	1 Class I	BK RAL 9005 black	A2 250 hrs AISI 304
	40W	2M2 Medium T.II	27K 2.700K	8 80						24T1 220-240 VAC Prog. DALI-2, ZH/24V
	55W	2S1 Short T.II	30K 3.000K		24T2 220-240 VAC Prog. DALI-2					B2 500 hrs AISI 304
	75W	2S2 Short T.II	40K 4.000K							B4 500 hrs AISI 316
	100W	2S3 Short T.II								C2 1000 hrs AISI 304
			2S4 Short T.II							C4 1000 hrs AISI 316
		2S5 Short T.II								D2 1500 hrs AISI 304
		2S6 Short T.II								D4 1500 hrs AISI 316
		3M2 Medium T.III								** On request
		3S1 Short T.III								
5X1 Symmetric TV										
PR1 Right pedestrian										
PL1 Left pedestrian										

References	3.000K	
	Lumens	LPW
FDA2-25W2M1-30K7-24FL-CL20P-1_BK-A2	> 3.500	> 140
FDA2-40W2M1-30K7-24FL-CL20P-1_BK-A2	> 5.600	> 140
FDA2-55W2M1-30K7-24FL-CL20P-1_BK-A2	> 7.700	> 140
FDA2-75W2M1-30K7-24FL-CL20P-1_BK-A2	> 10.500	> 140
FDA2-100W2M1-30K7-24FL-CL20P-1_BK-A2	> 14.000	> 140

References	4.000K	
	Lumens	LPW
FDA2-25W2M1-40K7-24FL-CL20P-1_BK-A2	> 3.750	> 150
FDA2-40W2M1-40K7-24FL-CL20P-1_BK-A2	> 6.000	> 150
FDA2-55W2M1-40K7-24FL-CL20P-1_BK-A2	> 8.250	> 150
FDA2-75W2M1-40K7-24FL-CL20P-1_BK-A2	> 11.250	> 150
FDA2-100W2M1-40K7-24FL-CL20P-1_BK-A2	> 15.000	> 150

NOTE: The luminous flux values may vary depending on the selected luminaire configuration due to the different electrical insulation options, available optics, and the colourimetric and binning parameters of the LED diode.



Project: Silleda Town Council
Location: Pontevedra, Galicia
Luminaire: FEDORA Series

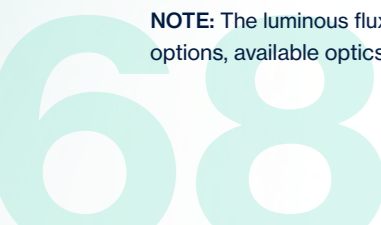



PUBLIC LIGHTING

LUGA Series - Bollard light

LUGA Series



LED bollard designed for outdoor lighting, standing out for its modern aesthetics and the high quality of its materials and finishes. Available in three heights, it offers low-power solutions with a compact and elegant design. It features two optics that provide precise and efficient light distribution: one aligned at 180° for pathways and another at 360° for open areas, ensuring uniform lighting in both applications.

With a maximum power of 50 W, its design prevents light emission above the horizontal plane, providing greater visual comfort for both pedestrians and drivers, while also preventing light pollution.



Features

- Extruded aluminium body with stainless steel screws
- Configuration: 3000K 80CRI (other configurations available on request)
- Luminous flux maintenance L90 > 100,000 hours
- Different photometric distributions depending on the application
- DALI-2 dimmable driver, adjustable via NFC
- Programmable at fixed power or by power step dimming
- Programmable from the control cabinet (optional)
- Individual surge protection device 20 kV
- Possibility of series connection

Dimensions



280 mm
A: 280 mm
B: 135 mm
C: Ø 180

600 mm
A: 600 mm
B: 135 mm
C: Ø 180

900 mm
A: 900 mm
B: 135 mm
C: Ø 180

Photometric curves

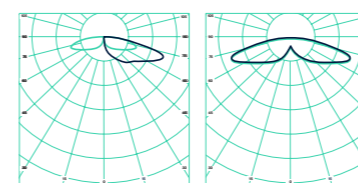

T5X1 T5X2

cd/klm
— C0 - C180
— C90 - C270



Project: Santiago Town Council
Location: A Coruña, Galicia
Luminaire: LUGA Series

Reference configurator

Model	Power	Optics	CCT	CRI	Driver	Elements	SPD	EL. class	RAL color	Treatment	Height
LUG1 Series 1	10W	5X1 TV 180°	22K 2.200K	8 80	27M2 100-277 VAC Prog. Reg. 0-10 V,PWM	gg Without elements	20C 20kV	1 Class I	BK RAL 9005 black	D2 1500h AISI 304	280 Height 280 mm
	20W	5X2 TV 360°	27K 2.700K	9 90	24T2 220-240 VAC Prog. DALI-2	PR PR sensor		2 Class II ²	** On request	D4 1500h AISI 316	600 Height 600 mm
	25W¹		30K 3.000K			FC Photocell				** On request	900 Height 900 mm
	30W		40K 4.000K							** On request	
	40W										
	50W										

¹ Maximum power available for the 5X1 configuration

² Electrical class available with the 24T2 configuration

References	3.000K	
	Lumens	LPW
LUG1-10W5X2-30K8-27M2-gg20C-1_BK-D4-280	> 700	> 70
LUG1-20W5X2-30K8-27M2-gg20C-1_BK-D4-280	> 1400	> 70
LUG1-25W5X2-30K8-27M2-gg20C-1_BK-D4-280	> 1750	> 70
LUG1-30W5X2-30K8-27M2-gg20C-1_BK-D4-280	> 2100	> 70
LUG1-40W5X2-30K8-27M2-gg20C-1_BK-D4-280	> 2800	> 70
LUG1-50W5X2-30K8-27M2-gg20C-1_BK-D4-280	> 3500	> 70

References	4.000K	
	Lumens	LPW
LUG1-10W5X2-40K8-27M2-gg20C-1_BK-D4-280	> 800	> 75
LUG1-20W5X2-40K8-27M2-gg20C-1_BK-D4-280	> 1600	> 75
LUG1-25W5X2-40K8-27M2-gg20C-1_BK-D4-280	> 1900	> 75
LUG1-30W5X2-40K8-27M2-gg20C-1_BK-D4-280	> 2400	> 75
LUG1-40W5X2-40K8-27M2-gg20C-1_BK-D4-280	> 3200	> 75
LUG1-50W5X2-40K8-27M2-gg20C-1_BK-D4-280	> 3700	> 75

NOTE: The luminous flux values may vary depending on the selected luminaire configuration due to the different electrical insulation options, available optics, and the colourimetric and binning parameters of the LED diode.





solar lighting

76 – AERIS Series

Project: Santiago Town Council
Location: A Coruña, Galicia
Luminaire: AERIS Series

75



ALUMBRADO SOLAR

AERIS Series - Solar Street light

AERIS Series

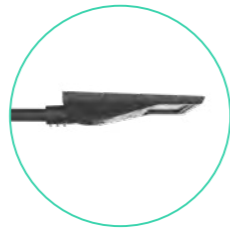

Installation on pole



Installation on column

The **AERIS Series** luminaire is a compact all-in-one solar solution, with a modern and functional design that adapts perfectly to public lighting applications. It incorporates a motion sensor and an intelligent controller that optimises energy performance.

Equipped with a high-efficiency monocrystalline silicon solar panel and a deep-cycle lithium battery, the AERIS Series guarantees autonomous operation for several days on a single charge, making it the ideal option for projects in remote areas and areas without access to the electrical grid.



Features

- Die-cast aluminium body with stainless steel screws
- Posibilidad de inclinacion -15° / $+15^{\circ}$
- Configuration: 3000K 70CRI (other configurations available on request)
- Mantenimiento lumínico L70 > 100.000 horas
- Different photometric distributions depending on the application
- Panel solar monocristalino de alta eficiencia
- Programmable at fixed power or by power step dimming (a través de control remoto)
- Tool-free opening

Dimensions

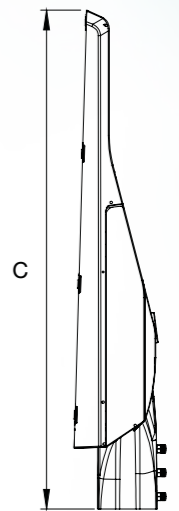
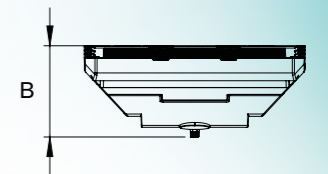
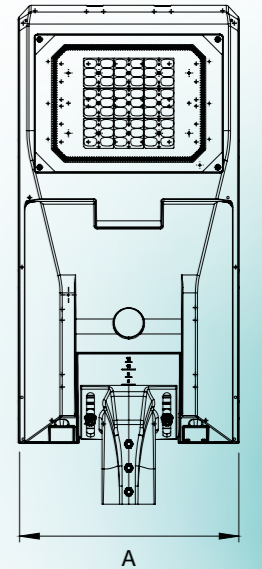
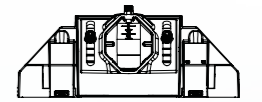

20/24W	40/45W
A: 370 mm	A: 475 mm
B: 153mm	B: 157 mm
C: 835 mm	C: 1105 mm

Photometric curves

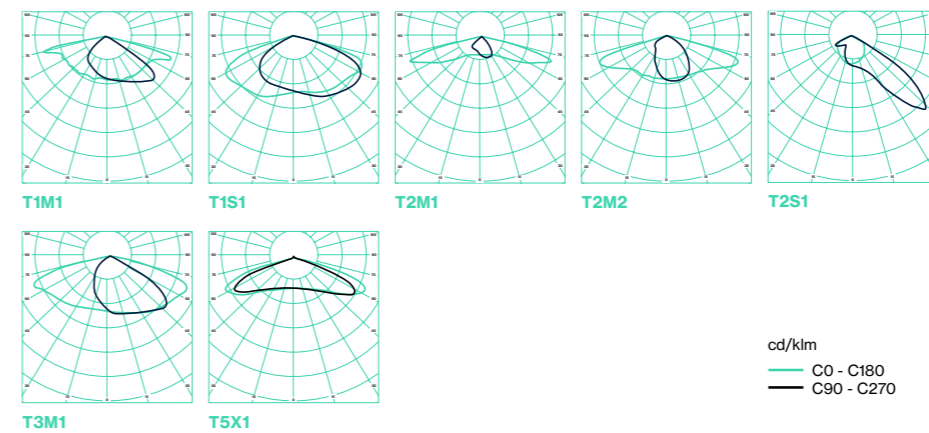

76

77



Reference configurator

Model	Power	Optics	CCT	CRI	Controller	Battery	Elements	RAL color	Treatment
AER1 Series 1	20W	1M1 Medium T.I	27K 2.700K	7 70	12L1 12V 8A	18A Li-ion 12,8V 18Ah	PIR PIR sensor	GY RAL 7010 grey	A2 250 hrs AISI 304
	24W	1S1 Short T.I	30K 3.000K	8 80		30A Li-ion 12,8V 30Ah	MIC Microwave sensor	** On request	A4 250 hrs AISI 316
	40W	2M1 Medium T.II	40K 4.000K		48A Li-ion 12,8V 48Ah			B2 500 hrs AISI 304	
	45W	2M2 Medium T.II			60A Li-ion 12,8V 60Ah			B4 500 hrs AISI 316	
		2S1 Short T.II						C2 1000 hrs AISI 304	
		3M1 Medium T.III						C4 1000 hrs AISI 316	
5X1 Symmetric T.V							D2 1500 hrs AISI 304		
							D4 1500 hrs AISI 316		
							** On request		

References	3.000K	
	Lumens	LPW
AER1-20W2M1-30K7-12L1-**APIR_GY-A2	>3.700	>185
AER1-24W2M1-30K7-12L1-**APIR_GY-A2	>4.320	>180
AER1-40W2M1-30K7-12L1-**APIR_GY-A2	>7.400	>185
AER1-45W2M1-30K7-12L1-**APIR_GY-A2	>8.100	>180

References	4.000K	
	Lumens	LPW
AER1-20W2M1-40K7-12L1-**APIR_GY-A2	>3.900	>195
AER1-24W2M1-40K7-12L1-**APIR_GY-A2	>4.560	>190
AER1-40W2M1-40K7-12L1-**APIR_GY-A2	>7.800	>195
AER1-45W2M1-40K7-12L1-**APIR_GY-A2	>8.550	>190

NOTE: The luminous flux values may vary depending on the selected luminaire configuration due to the different electrical insulation options, available optics, and the colourimetric and binning parameters of the LED diode.





columns & supports

82 – **NARIGA** Series

84 – **VELA** Series

Project: Santiago Town Council
Location: A Coruña, Galicia
Column: NARIGA Series 2A

81



NARIGA Series

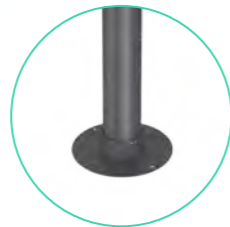

With decorative cover

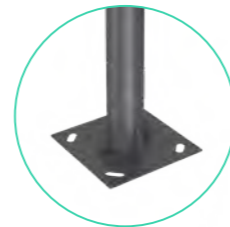

Without decorative cover

The **NARIGA Series** column range is an excellent option for projects requiring a durable, elegant and functional public lighting solution.

Available in different heights and configurations, NARIGA Series is manufactured from galvanised steel with a coating that provides the entire assembly with excellent outdoor resistance.

Its flawless construction and the unchanging nature of the material used give the assembly unwavering resistance to the passage of time and to any act of vandalism.

NARIGA Series is ideal for use in a wide range of applications, including streets/avenues, parks/gardens, car parks, walkways/paths, residential areas and commercial areas.



Configurations / Dimensions

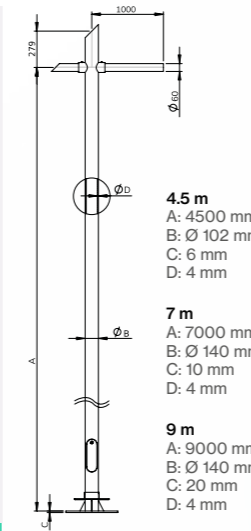

4.5 m
A: 4500 mm
B: Ø 102 mm
C: 6 mm
D: 4 mm

7 m
A: 7000 mm
B: Ø 140 mm
C: 10 mm
D: 4 mm

9 m
A: 9000 mm
B: Ø 140 mm
C: 20 mm
D: 4 mm

1B

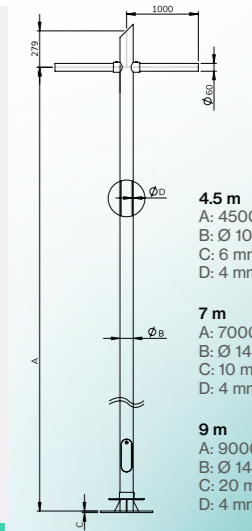

4.5 m
A: 4500 mm
B: Ø 102 mm
C: 6 mm
D: 4 mm

7 m
A: 7000 mm
B: Ø 140 mm
C: 10 mm
D: 4 mm

9 m
A: 9000 mm
B: Ø 140 mm
C: 20 mm
D: 4 mm

2B

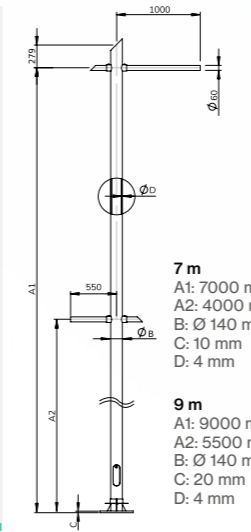

7 m
A1: 7000 mm
A2: 4000 mm
B: Ø 140 mm
C: 10 mm
D: 4 mm

9 m
A1: 9000 mm
A2: 5500 mm
B: Ø 140 mm
C: 20 mm
D: 4 mm

2A

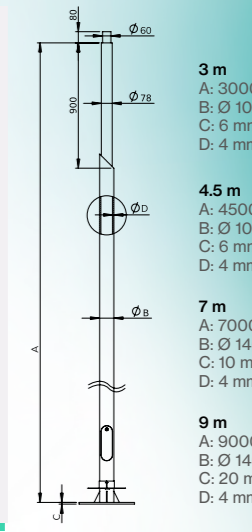

3 m
A: 3000 mm
B: Ø 102 mm
C: 6 mm
D: 4 mm

4.5 m
A: 4500 mm
B: Ø 102 mm
C: 6 mm
D: 4 mm

7 m
A: 7000 mm
B: Ø 140 mm
C: 10 mm
D: 4 mm

9 m
A: 9000 mm
B: Ø 140 mm
C: 20 mm
D: 4 mm

CV

Reference configurator

Model	Height	Configuration	RAL color	Treatment
NAR1 Series 1	300' 3 m	1B One bracket	GY RAL 7010 grey	A2 250 h AISI 304
	450 4,5 m	2B Two brackets	BK RAL 9005 black	A4 250 h AISI 316
	700 7 m	2A Two heights	** On request	** On request
	900 9 m	CV Vertical column		

¹ Height available for the CV configuration.



VELA

Series



With customer logo



Without customer logo

The **VELA Series** support is an excellent option for projects requiring a public lighting solution that combines functionality and aesthetics.

It stands out for its curved, minimalist design, giving it a modern and discreet appearance that adapts to various urban environments.

Available in two sizes, VELA Series is manufactured from galvanised steel with a coating that provides the entire assembly with excellent outdoor resistance.

VELA Series is ideal for use in a wide range of applications, including urban centres, parks/squares, residential and commercial areas.



Dimensions



520

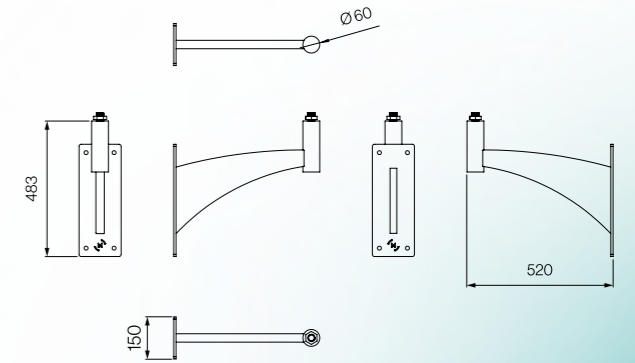

785

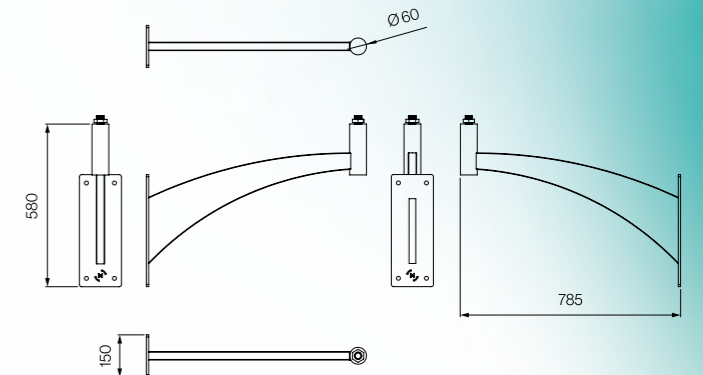

Reference configurator

Model	Length	RAL color	Treatment
VEL1 Series 1	520 520 mm	BK RAL 9005 black	A2 250 h AISI 304
	785 785 mm	** On request	A4 250 h AISI 316
			** On request

Project: As Gándaras Football Field
Location: Lugo, Galicia
Luminaire: LAMAR Series



Sports and industrial lighting

- 88 – **BUSIER** Series Mini
- 92 – **BUSIER** Series Start
- 96 – **LAMAR** Series
- 102 – **GAUDÍ** Series - High Bay
- 106 – **DELTA** Series



BUSIER

Series Mini



Wall installation



Pole installation

LED floodlight designed for outdoor and sports lighting, combining modern and innovative aesthetics with optimal thermal management. Its modular design allows it to offer a wide range of low- and medium-power solutions.

The **BUSIER Series** range is the professional and robust choice that meets the highest quality standards on the market. It offers numerous possible configurations by using standard components designed to extend the product's service life, while also allowing replacement and upgrading.

Available up to a power of 100 W, BUSIER Series Mini offers high efficiency and versatility, making it the trusted choice for lighting the most demanding projects.



Features

- Die-cast aluminium body with stainless steel screws
- Tilt adjustment possible -90° / +90° progressive
- Configuration: 3000K 70CRI (other configurations available on request)
- Luminous flux maintenance L90 > 100,000 hours
- Different photometric distributions depending on the application
- DALI-2 dimmable driver, adjustable via NFC
- Programmable at fixed power or by power step dimming
- Programmable from the control cabinet (optional)
- Individual surge protection device 20 kV
- Possibility of use with NEMA or ZHAGA socket (lower/upper)
- Tool-free opening

Dimensions

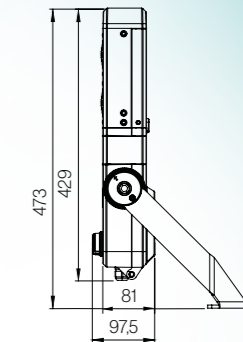
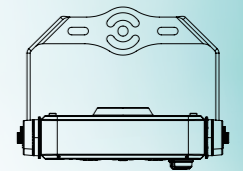
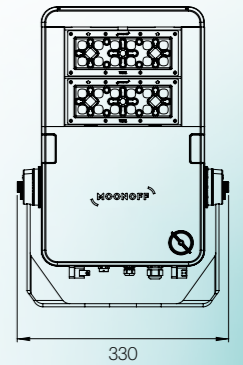
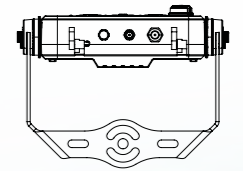

Photometric curves

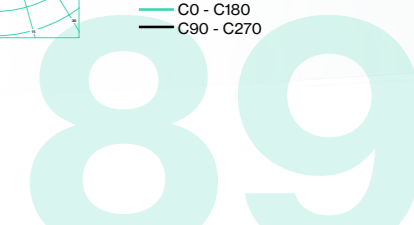
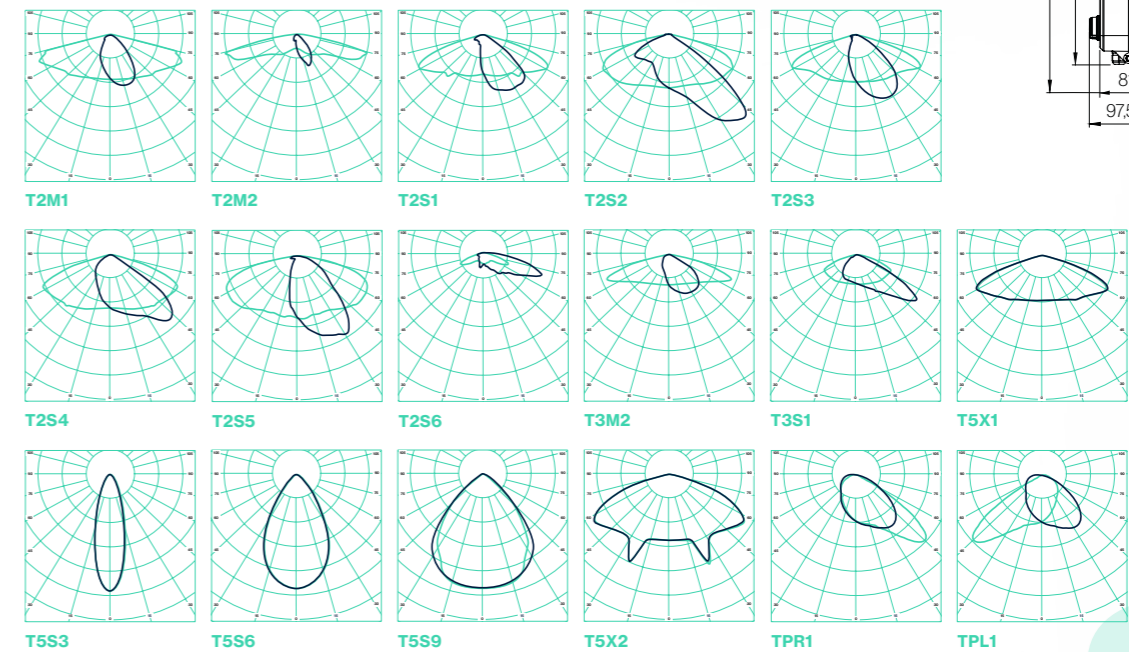



Reference configurator

Model	Power	Optics	CCT	CRI	Driver	Elements	SPD	EL. class	RAL color	Treatment	
BUM1 Series 1	25W	2M1 Medium T.II	22K 2.200K	7 70	24DI 220-240 VAC Prog. DALI-2, D4I	CL Smooth cover	20P 20kV	1 Class I	GY RAL 7010 grey	A2 250 hrs AISI 304	
	50W	2M2 Medium T.II	27K 2.700K	8 80	24FL 220-240 VAC Prog. DALI-2, ZH/24V	ZS Upper Zhaga socket	20C 20kV	2 Class II	** On request	A4 250 hrs AISI 316	
	75W	2S1 Short T.II	30K 3.000K		24T2 220-240 VAC Prog. DALI-2	ZI Lower Zhaga socket				B2 500 hrs AISI 304	
	100W	2S2 Short T.II	40K 4.000K		27I1 100-277 VAC Prog. DALI-2	Z2 Upper Zhaga socket + lower					B4 500 hrs AISI 316
		2S3 Short T.II	50K 5.000K			NZ Upper NEMA socket + lower Zhaga					C2 1000 hrs AISI 304
		2S4 Short T.II				S3 3-pin NEMA socket					C4 1000 hrs AISI 316
		2S5 Short T.II				S5 5-pin NEMA socket					D2 1500 hrs AISI 304
		2S6 Short T.II				S7 7-pin NEMA socket					D4 1500 hrs AISI 316
		3M2 Medium T.III									** On request
		3S1 Short T.III									
		5S3 TV 30°									
		5S6 TV 60°									
		5S9 TV 90°									
	5X1 Symmetric TV										
	5X2 Symmetric TV										
PR1 Right pedestrian											
PL1 Left pedestrian											

References	3.000K	
	Lumens	LPW
BUM1-25W2M1-30K7-24FL-CL20P-1_GY-A2	> 3.375	> 135
BUM1-50W2M1-30K7-24FL-CL20P-1_GY-A2	> 6.750	> 135
BUM1-75W2M1-30K7-24FL-CL20P-1_GY-A2	> 10.125	> 135
BUM1-100W2M1-30K7-24FL-CL20P-1_GY-A2	> 13.500	> 135

References	4.000K	
	Lumens	LPW
BUM1-25W2M1-40K7-24FL-CL20P-1_GY-A2	> 3.500	> 140
BUM1-50W2M1-40K7-24FL-CL20P-1_GY-A2	> 7.000	> 140
BUM1-75W2M1-40K7-24FL-CL20P-1_GY-A2	> 10.500	> 140
BUM1-100W2M1-40K7-24FL-CL20P-1_GY-A2	> 14.000	> 140

NOTE: The luminous flux values may vary depending on the selected luminaire configuration due to the different electrical insulation options, available optics, and the colourimetric and binning parameters of the LED diode.

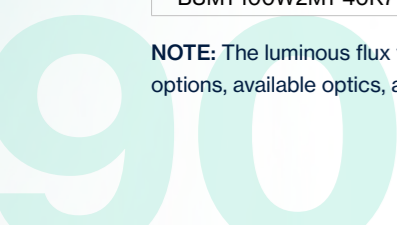



BUSIER

Series Start



Wall installation



Pole installation

LED floodlight designed for outdoor and sports lighting, combining modern and innovative aesthetics with optimal thermal management. Its modular design allows it to offer a wide range of low- and medium-power solutions.

The **BUSIER Series** range is the professional and robust choice that meets the highest quality standards on the market. It offers numerous possible configurations by using standard components designed to extend the product's service life, while also allowing replacement and upgrading.

Available up to a power of 200 W, BUSIER Series Start offers high efficiency and versatility, making it the trusted choice for lighting the most demanding projects.



Features

- Die-cast aluminium body with stainless steel screws
- Tilt adjustment possible -90° / +90° progressive
- Configuration: 3000K 70CRI (other configurations available on request)
- Luminous flux maintenance L90 > 100,000 hours
- Different photometric distributions depending on the application
- DALI-2 dimmable driver, adjustable via NFC
- Programmable at fixed power or by power step dimming
- Programmable from the control cabinet (optional)
- Individual surge protection device 20 kV
- Possibility of use with NEMA or ZHAGA socket (lower/upper)
- Tool-free opening

Dimensions

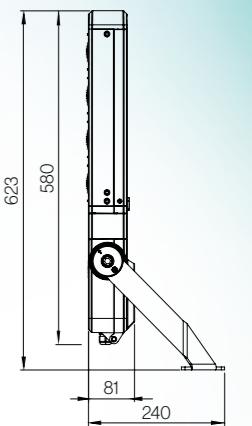
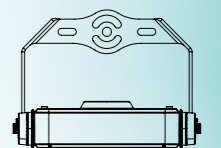
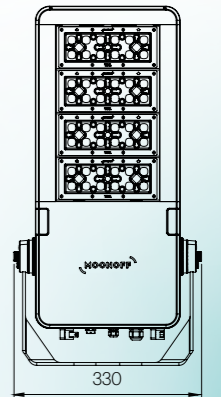
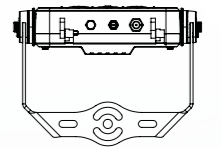

Photometric curves

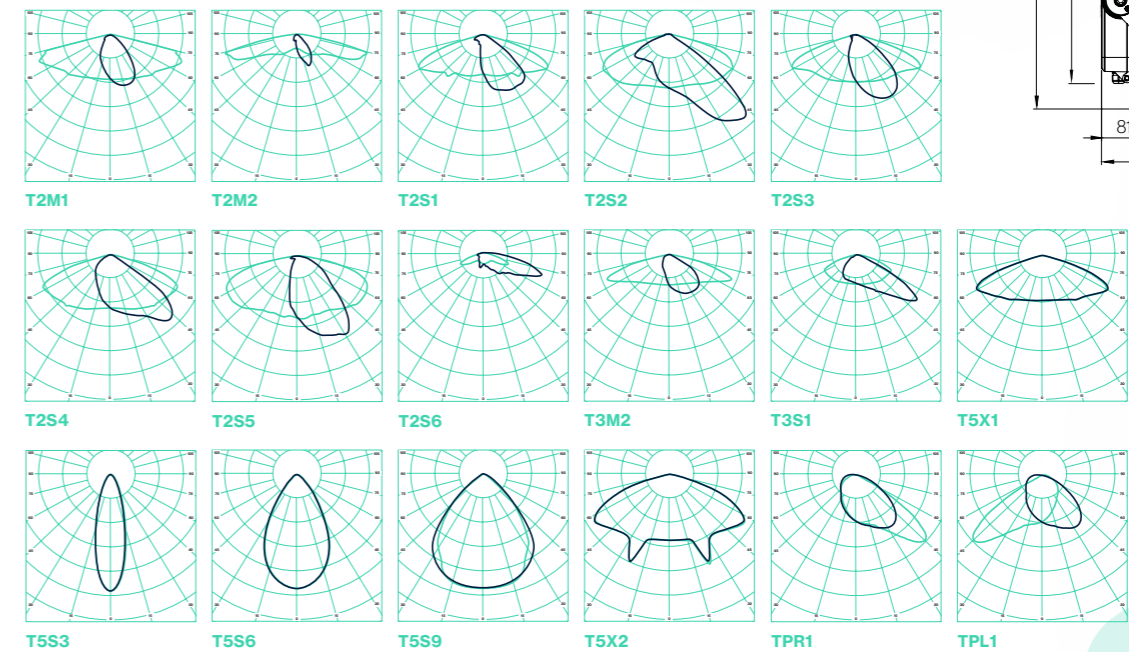

cd/klm
— C0 - C180
— C90 - C270





Reference configurator

Model	Power	Optics	CCT	CRI	Driver	Elements	SPD	EL. class	RAL color	Treatment
BUS1 Series 1	125W	2M1 Medium T.II	22K 2.200K	7 70	24DI 220-240 VAC Prog. DALI-2, D4I	CL Smooth cover	20P 20kV	1 Class I	GY RAL 7010 grey	A2 250 hrs AISI 304
	150W	2M2 Medium T.II	27K 2.700K	8 80		24FL 220-240 VAC Prog. DALI-2, ZH/24V				ZS Upper Zhaga socket
	175W	2S1 Short T.II	30K 3.000K		24T2 220-240 VAC Prog. DALI-2	ZI Lower Zhaga socket				B2 500 hrs AISI 304
	200W	2S2 Short T.II	40K 4.000K			27I1 100-277 VAC Prog. DALI-2	Z2 Upper Zhaga socket + lower			
		2S3 Short T.II	50K 5.000K			NZ Upper NEMA socket + lower Zhaga				C2 1000 hrs AISI 304
		2S4 Short T.II				S3 3-pin NEMA socket				C4 1000 hrs AISI 316
		2S5 Short T.II				S5 5-pin NEMA socket				D2 1500 hrs AISI 304
		2S6 Short T.II				S7 7-pin NEMA socket				D4 1500 hrs AISI 316
		3M2 Medium T.III								** On request
		3S1 Short T.III								
		5S3 TV 30°								
		5S6 TV 60°								
		5S9 TV 90°								
	5X1 Symmetric TV									
	5X2 Symmetric TV									
	PR1 Right pedestrian									
PL1 Left pedestrian										

References	3.000K	
	Lumens	LPW
BUS1-125W2M1-30K7-24FL-CL20P-1_GY-A2	> 16.875	> 135
BUS1-150W2M1-30K7-24FL-CL20P-1_GY-A2	> 20.250	> 135
BUS1-175W2M1-30K7-24FL-CL20P-1_GY-A2	> 23.625	> 135
BUS1-200W2M1-30K7-24FL-CL20P-1_GY-A2	> 27.000	> 135

References	4.000K	
	Lumens	LPW
BUS1-125W2M1-40K7-24FL-CL20P-1_GY-A2	> 17.500	> 140
BUS1-150W2M1-40K7-24FL-CL20P-1_GY-A2	> 21.000	> 140
BUS1-175W2M1-40K7-24FL-CL20P-1_GY-A2	> 24.500	> 140
BUS1-200W2M1-40K7-24FL-CL20P-1_GY-A2	> 28.000	> 140

NOTE: The luminous flux values may vary depending on the selected luminaire configuration due to the different electrical insulation options, available optics, and the colourimetric and binning parameters of the LED diode.





LAMAR Series

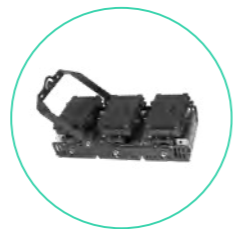

Wall installation



Pole installation

High-power LED luminaire for public lighting, sports lighting and large areas. Its modular design allows it to offer the sector different high-power solutions with the same aesthetic.

The **LAMAR Series** floodlight is a professional, robust solution that meets the highest quality standards on the market.

Its features include high luminous efficacy and a wide range of optical solutions. Thanks to this and to its modular design, which allows it to reach up to 1800 W, the LAMAR Series model becomes a reliable and guaranteed option for lighting the most demanding projects in terms of lighting levels and uniformity.



Features

- Die-cast aluminium body with stainless steel screws
- Tilt adjustment possible -90° / +90° progressive
- Configuration: 3000K 70CRI (other configurations available on request)
- Luminous flux maintenance L90 > 100,000 hours
- Different photometric distributions depending on the application
- 0-10 V/PWM and DALI-2 dimmable driver
- Programmable at fixed power or by power step dimming
- Individual surge protection device 20 kV
- Possibility of use with NEMA or ZHAGA socket

Dimensions

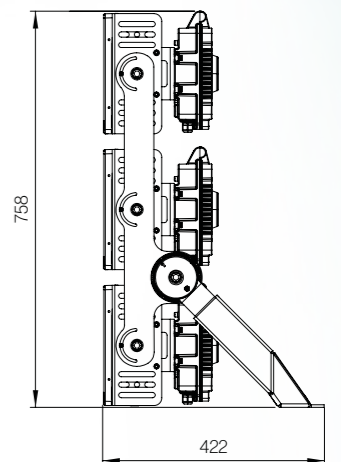
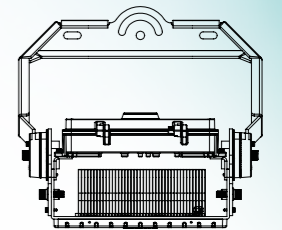
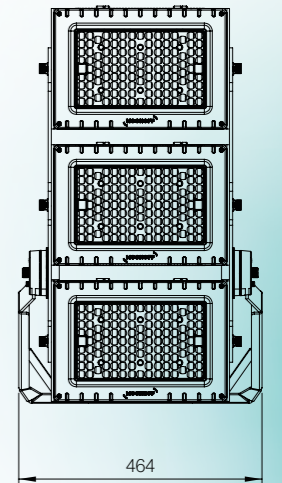
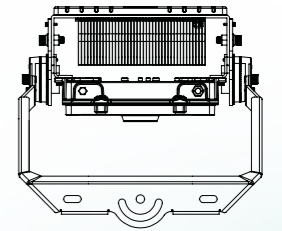

Photometric curves

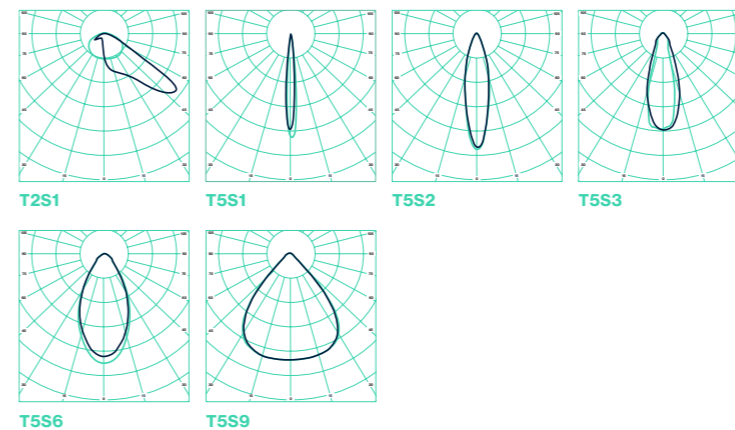

cd/klm
— C0 - C180
— C90 - C270



Reference configurator

Model	Power	Optics	CCT	CRI	Driver	Elements	SPD	EL. class	RAL color	Treatment
LAM1 Series 1	250W	2S1 Short T.II	27K 2.700K	7 70	27M1 100-277 VAC Prog. Reg. 0-10 V	gg	20P 20KV	1 Class I	GY RAL 7010 grey	A2 250 hrs AISI 304
	300W	5S1 TV 10°	30K 3.000K	8 80	27H1 100-277 VAC Prog. DALI-2, ZH/24 V	CS IP cover lid	20C 20KV		** On request	A4 250 hrs AISI 316
	500W	5S2 TV 20°	40K 4.000K			ZS Upper Zhaga socket				B2 500 hrs AISI 304
	600W	5S3 TV 30°	50K 5.000K			S3 Socket NEMA 3 pins				B4 500 hrs AISI 316
	750W	5S6 TV 60°	57K 5.700K			S5 Socket NEMA 5 pins				C2 1000 hrs AISI 304
	900W	5S9 TV 90°				S7 Socket NEMA 7 pins				C4 1000 hrs AISI 316
	1000W									D2 1500 hrs AISI 304
	1200W									D4 1500 hrs AISI 316
	1500W									** On request
	1800W									

References	4.000K	
	Lumens	LPW
LAM1-250W5S2-40K7-27M1-gg20P-1_GY-A4	> 37.500	> 150
LAM1-300W5S2-40K7-27M1-gg20P-1_GY-A4	> 45.000	> 150
LAM1-500W5S2-40K7-27M1-gg20P-1_GY-A4	> 75.000	> 150
LAM1-600W5S2-40K7-27M1-gg20P-1_GY-A4	> 90.000	> 150
LAM1-750W5S2-40K7-27M1-gg20P-1_GY-A4	> 112.500	> 150
LAM1-900W5S2-40K7-27M1-gg20P-1_GY-A4	> 135.000	> 150
LAM1-1000W5S2-40K7-27M1-gg20P-1_GY-A4	> 150.000	> 150
LAM1-1200W5S2-40K7-27M1-gg20P-1_GY-A4	> 180.000	> 150
LAM1-1500W5S2-40K7-27M1-gg20P-1_GY-A4	> 225.000	> 150
LAM1-1800W5S2-40K7-27M1-gg20P-1_GY-A4	> 270.000	> 150
References	5.000K	
	Lumens	LPW
LAM1-250W5S2-50K7-27M1-gg20P-1_GY-A4	> 38.750	> 155
LAM1-300W5S2-50K7-27M1-gg20P-1_GY-A4	> 46.500	> 155
LAM1-500W5S2-50K7-27M1-gg20P-1_GY-A4	> 77.500	> 155
LAM1-600W5S2-50K7-27M1-gg20P-1_GY-A4	> 93.000	> 155
LAM1-750W5S2-50K7-27M1-gg20P-1_GY-A4	> 116.250	> 155
LAM1-900W5S2-50K7-27M1-gg20P-1_GY-A4	> 139.500	> 155
LAM1-1000W5S2-50K7-27M1-gg20P-1_GY-A4	> 155.000	> 155
LAM1-1200W5S2-50K7-27M1-gg20P-1_GY-A4	> 186.000	> 155
LAM1-1500W5S2-50K7-27M1-gg20P-1_GY-A4	> 232.500	> 155
LAM1-1800W5S2-50K7-27M1-gg20P-1_GY-A4	> 279.000	> 155

NOTE: The luminous flux values may vary depending on the selected luminaire configuration due to the different electrical insulation options, available optics, and the colourimetric and binning parameters of the LED diode.



Maximum adaptability in your sports facility.

Moonoff's smart lighting system for sports facilities combines a simple architecture with exceptional flexibility. It maximises space optimisation without sacrificing control, adapting to the specific needs of football pitches, tennis and padel courts, multi-sport areas and much more.



Project: El Toboso Football Field
Location: Toledo, Castilla-La Mancha
Luminaire: LAMAR Series

EASE OF USE: Light according to your needs. Create customised scenes, distinguishing between training and competition.

WIRELESS: No additional wiring required.

PLUG & PLAY: Simple installation. Connect and start controlling your installation.

EFFICIENT: Energy optimisation that guarantees efficient and sustainable installations.

PROFITABLE: Savings in maintenance costs. Extends the service life of the equipment and reduces the replacement rate.

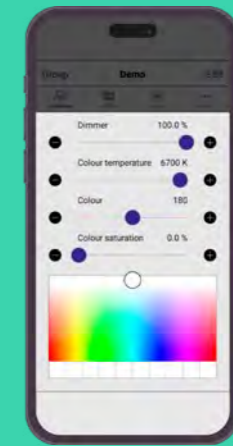

APP (Android & iOS)
Enjoy an intuitive and easy-to-use mobile application on any device. Access full control of your lighting installation, managing multiple scenes by controlling power levels, on/off switching, colour and many more options.

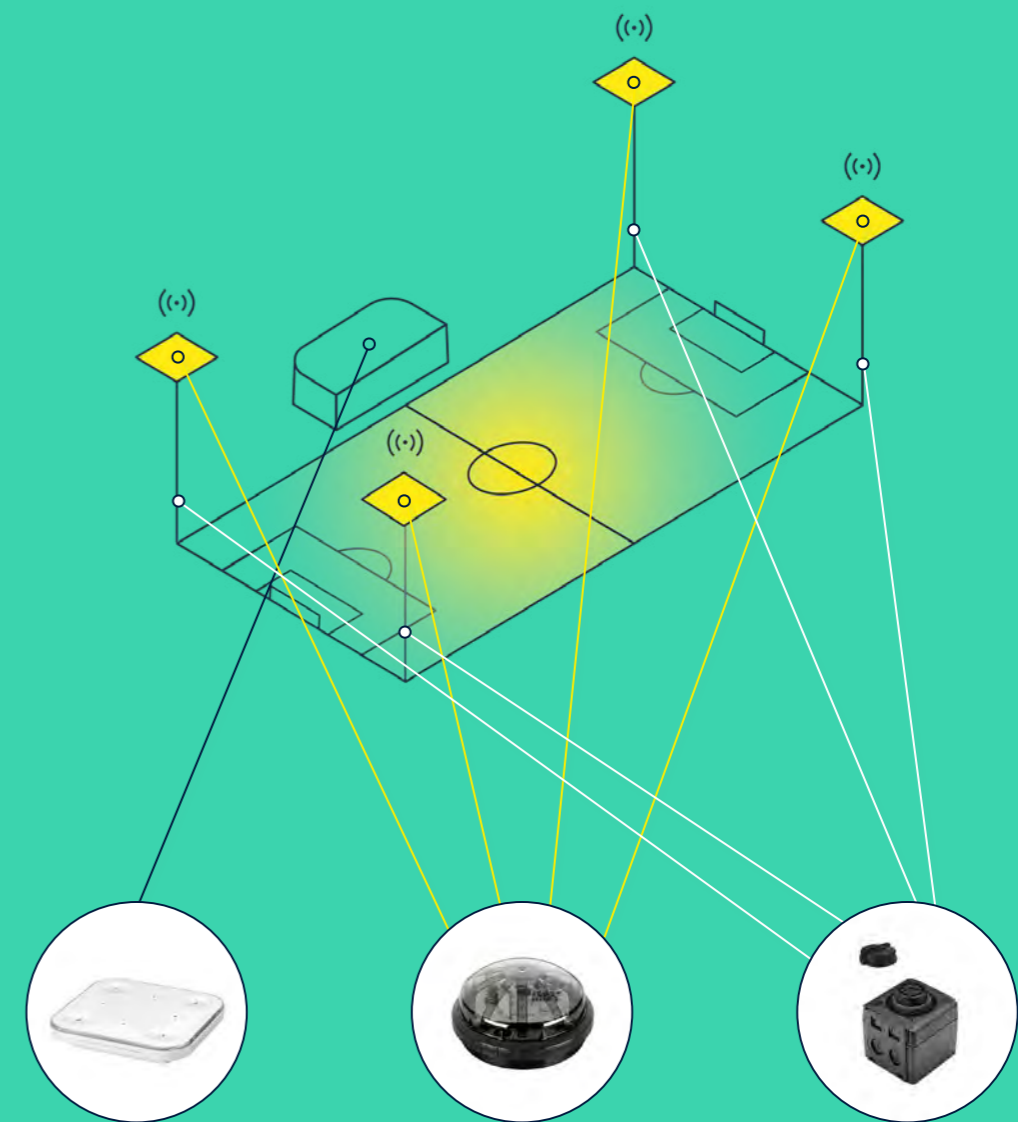

Remote control
Configurable and programmable control terminal for controlling your installation easily and quickly at the touch of a button.

Zhaga Book 18 node
Plug & play control device enabling remote control of each floodlight individually.

Smartbox enclosure
Watertight enclosure with Zhaga Book 18 socket that centralises the connections and connectivity of a set of floodlights.



SPORTS AND INDUSTRIAL LIGHTING

GAUDÍ Series - High Bay

GAUDÍ Series

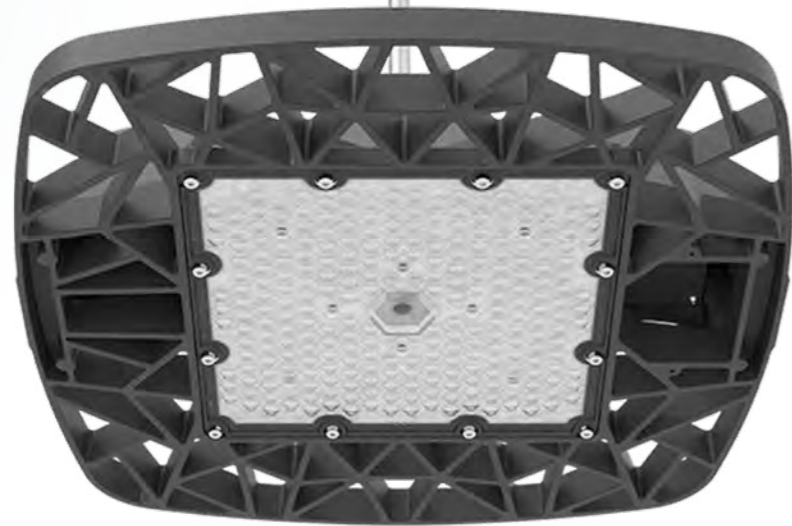

Fixed bar installation



Chain installation

High-bay LED luminaire designed for industrial or sports lighting, with a modern and innovative design that guarantees perfect thermal management of the product.

GAUDÍ Series is a luminaire inspired by the work of the renowned modernist architect Antoni Gaudí, whose aesthetics evoke the famous artist's mosaics while offering great functional versatility, enabling installation in various projects.

The elegance, robustness, high efficiency and versatility of this luminaire make it ideal for use in industrial environments, with fixed-bar installation recommended to preserve the aesthetics of the site.



Features

- Die-cast aluminium body with stainless steel screws
- Optimised passive thermal dissipation to ensure service life
- Configuration: 3000K 80CRI (other configurations available on request)
- Luminous flux maintenance L90 > 100,000 hours
- Different photometric distributions depending on the application
- 1-10 V/PWM dimmable driver and DALI-2
- Programmable at fixed power or by power step dimming

Dimensions

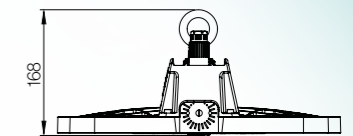
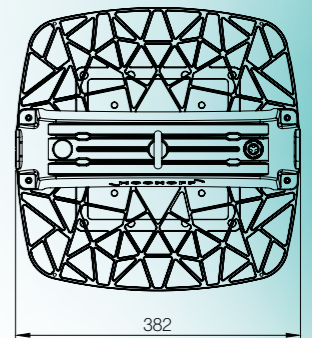
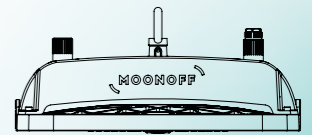
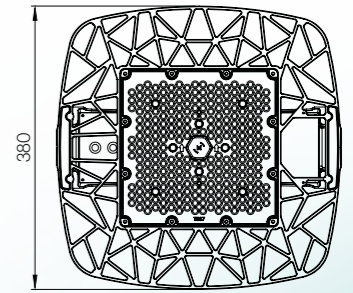

Photometric curves

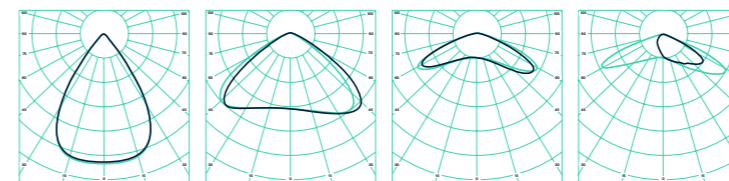

T5S7 T5S9 T5X1 T3S1

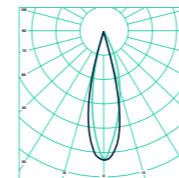

T5S3

cd/klm
— C0 - C180
— C90 - C270



Series 2

Reference configurator

Model	Power	Optics	CCT	CRI	Driver	Elements	SPD	EL. class	RAL color	Treatment
GDI2 Series 2	75W	5S7 TV 70°	22K 2.200K	8 80	2711 100-277 VAC Prog. DALI-2, D4i	gg	10S Internal pro.	1 Class I	GY RAL 7010 grey	A2 250 hrs AISI 304
	100W	5S9 TV 90°	27K 2.700K	2712 100-277 VAC Prog. REg. 1-10V, PWM						** On request
	150W	5X1 TV 120°	30K 3.000K		B2 500 hrs AISI 304					
	200W	3S1 Short T.III	40K 4.000K		B4 500 hrs AISI 316					
		5S3 TV 35°	50K 5.000K	C2 1000 hrs AISI 304						
										C4 1000 hrs AISI 316
										D2 1500 hrs AISI 304
										D4 1500 hrs AISI 316
										** On request

References	3.000K	
	Lumens	LPW
GDI2-75W5S7-30K8-2711-gg10S-1_GY-A2	> 10.875	> 145
GDI2-100W5S7-30K8-2711-gg10S-1_GY-A2	> 14.000	> 140
GDI2-150W5S7-30K8-2711-gg10S-1_GY-A2	> 19.500	> 130
GDI2-200W5S7-30K8-2711-gg10S-1_GY-A2	> 24.000	> 120

References	4.000K	
	Lumens	LPW
GDI2-75W5S7-40K8-2711-gg10S-1_GY-A2	> 11.625	> 155
GDI2-100W5S7-40K8-2711-gg10S-1_GY-A2	> 15.000	> 150
GDI2-150W5S7-40K8-2711-gg10S-1_GY-A2	> 21.000	> 140
GDI2-200W5S7-40K8-2711-gg10S-1_GY-A2	> 26.000	> 130

References	5.000K	
	Lumens	LPW
GDI2-75W5S7-50K8-2711-gg10S-1_GY-A2	> 12.000	> 160
GDI2-100W5S7-50K8-2711-gg10S-1_GY-A2	> 15.500	> 155
GDI2-150W5S7-50K8-2711-gg10S-1_GY-A2	> 21.750	> 145
GDI2-200W5S7-50K8-2711-gg10S-1_GY-A2	> 27.000	> 135

NOTE: The luminous flux values may vary depending on the selected luminaire configuration due to the different electrical insulation options, available optics, and the colourimetric and binning parameters of the LED diode.



Project: A Malata Sports Centre
Location: Ferrol, A Coruña, Galicia
Luminaire: GAUDÍ Series



DELTA Series



Suspended installation



Wall installation

Watertight LED fitting with optional emergency kit, providing the industrial sector with an efficient and lightweight product that guarantees uniform light distribution.

With a carefully designed and discreet appearance, the **DELTA Series** fixed luminaire is designed to replace old fluorescent fittings, resulting in a high-quality and efficient solution for lighting different types of locations.

Available for surface-mounted or suspended installation, depending on the technical or aesthetic requirements of the project.



Features

- Polycarbonate body with stainless steel screws
- Surface-mounted installation (accessories available for suspended mounting)
- Configuration: 4000K 70CRI (other configurations available on request)
- Luminous flux maintenance L70 > 50,000 hours
- 120° beam angle
- Possibility of series connection
- Possibility of integrated emergency kit

Dimensions

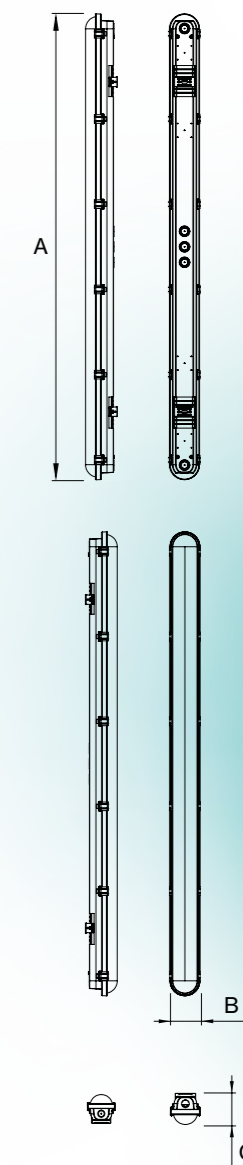

15 W
A: 600 mm
B: 83 mm
C: 72 mm

20/36 W
A: 1200 mm
B: 83 mm
C: 72 mm

50 W
A: 1500 mm
B: 83 mm
C: 72 mm

Photometric curves

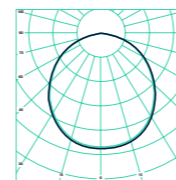

T12M

cd/klm
— C0 - C180
— C90 - C270



Reference configurator

Model	Power	Optics	CCT	CRI	Driver	Elements	SPD	EL. class	RAL color	Treatment	
DEL1 Series 1	15W	12M	30K 3.000K	7 70	24O1 220-240 VAC	2C Series connection	PID Internal pro.	1 Class I	GY RAL 7035	A2 250 hrs AISI 304	
	20W		40K 4.000K	8 80		E1 2 W emergency kit 180 min				** On request	A4 250 hrs AISI 316
	36W		50K 5.000K			EC Emergency kit + Series connection					
	50W					gg Without additional elements					

References	3.000K	
	Lumens	LPW
DEL1-15W12M-30K8-24O1-ggPID-1_GY-A2	> 1875	> 125
DEL1-20W12M-30K8-24O1-ggPID-1_GY-A2	> 2500	> 125
DEL1-36W12M-30K8-24O1-ggPID-1_GY-A2	> 4500	> 125
DEL1-50W12M-30K8-24O1-ggPID-1_GY-A2	> 6250	> 125

References	4.000K	
	Lumens	LPW
DEL1-15W12M-40K8-24O1-ggPID-1_GY-A2	> 1950	> 130
DEL1-20W12M-40K8-24O1-ggPID-1_GY-A2	> 2600	> 130
DEL1-36W12M-40K8-24O1-ggPID-1_GY-A2	> 4680	> 130
DEL1-50W12M-40K8-24O1-ggPID-1_GY-A2	> 6500	> 130

References	5.000K	
	Lumens	LPW
DEL1-15W12M-50K8-24O1-ggPID-1_GY-A2	> 2025	> 135
DEL1-20W12M-50K8-24O1-ggPID-1_GY-A2	> 2700	> 135
DEL1-36W12M-50K8-24O1-ggPID-1_GY-A2	> 4860	> 135
DEL1-50W12M-50K8-24O1-ggPID-1_GY-A2	> 6750	> 135

NOTE: The luminous flux values may vary depending on the selected luminaire configuration due to the different electrical insulation options, available optics, and the colourimetric and binning parameters of the LED diode.

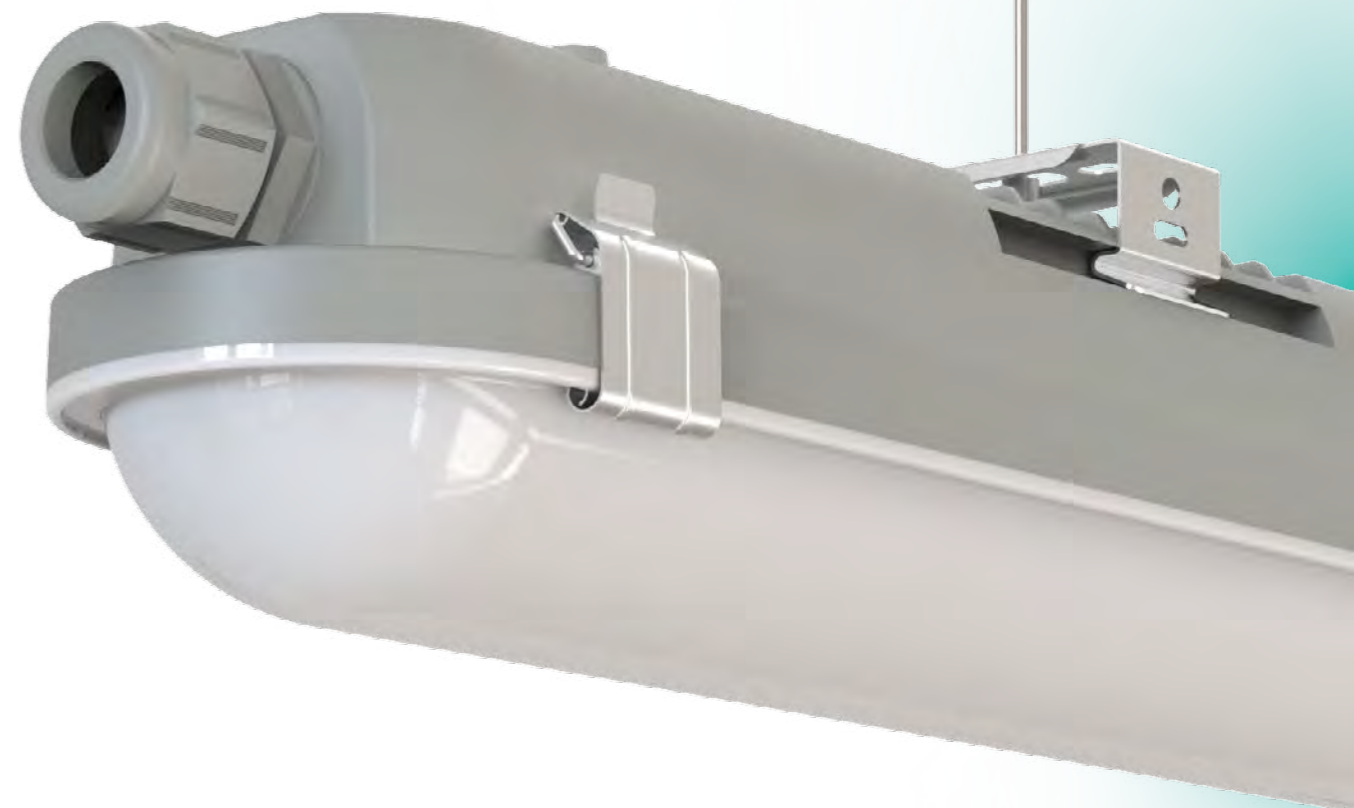



horticulture

112 – **GROW** Series



HORTICULTURE

GROW Series - Grow light

GROW Series



Innovative LED luminaire with a power-adjustable spectrum to provide ideal radiation, promoting and enhancing artificial crop cultivation and growth.

Based on multi-LED SMD technology, the configuration of the different diodes used creates a wavelength that provides higher performance and improved production care.

Available with a power of 640 W, with the possibility of adding optional bars with UV+IR radiation.

Electronic compartment located at the top to ensure homogeneous lighting across the entire light coverage area.



Features



Aluminium body with stainless steel screws



Foldable design for easier logistics



Installation for adjustable suspended mounting



Efficacy: 2.7 $\mu\text{mol}/\text{J}$



PPF: >1600 $\mu\text{mol}/\text{s}$



Possibility of series connection



0-10 V/PWM dimmable driver



Manually programmable by power steps



Programmable from controller

Dimensions

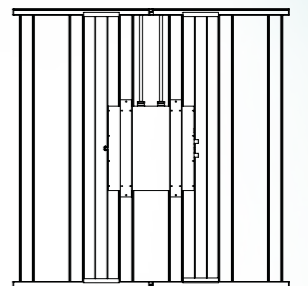
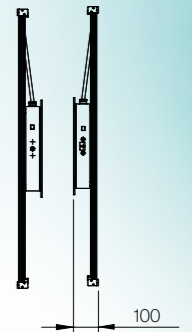
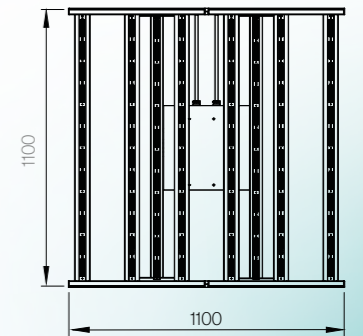

Spectrum

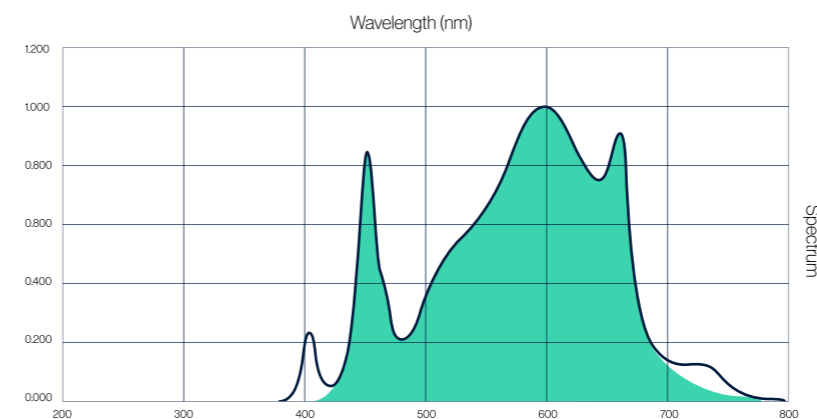

General spectrum

General spectrum + UV/IR bars



Reference configurator

Model	Power	Optics	CCT	CRI	Driver	Elements	SPD	EL. class	RAL color	Treatment
GRW1 Series 1	640W	120M 120°	SPE1 Spectrum 1	-	30H1 90-305 VAC Prog. Reg. 0-10V, PWM	gg	PID Internal pro.	1 Class I	GY Gris	A2 250 hrs AISI 304
					48H1 250-528 VAC Prog. Reg. 0-10V, PWM	UI UV+IR bars			** On request	A4 250 hrs AISI 316
										** On request

References	Voltaje nominal	UV + IR
GRW1-640W120-SPE1-30H1-ggPID-1_GY-A2	90-305 V AC	NO
GRW1-640W120-SPE1-30H1-UIPID-1_GY-A2		SI
GRW1-640W120-SPE1-48H1-ggPID-1_GY-A2	250-528 V AC	NO
GRW1-640W120-SPE1-48H1-UIPID-1_GY-A2		SI

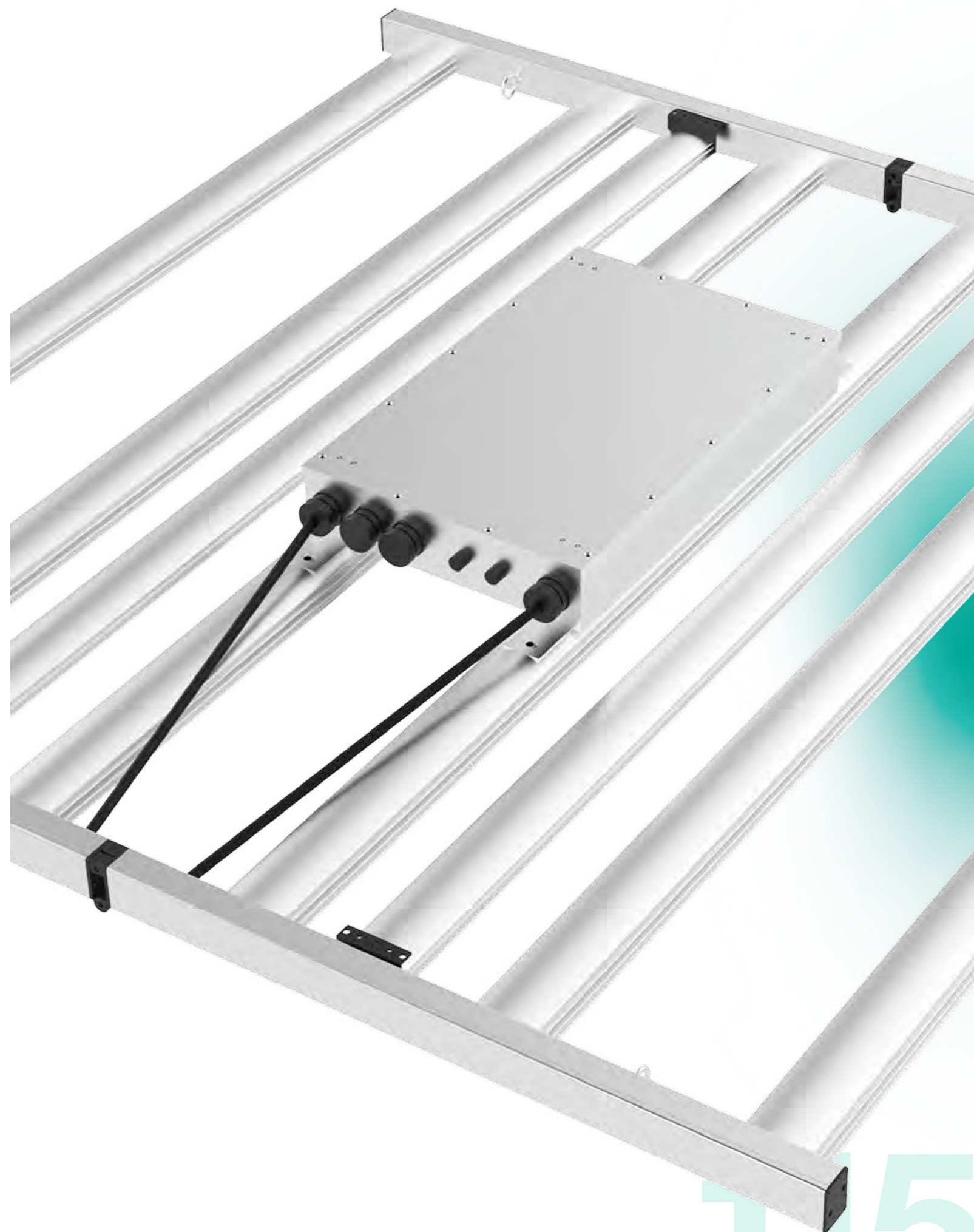



Project: Costa Vella Industrial Estate
Location: Santiago de Compostela, A Coruña, Galicia
REMOTE MANAGEMENT: KALMAN Project

remote management

118 – KALMAN Project

117



REMOTE MANAGEMENT

KALMAN Project - Smart Lighting Platform

KALMAN Project



Moonoff's **KALMAN Project** web platform is a comprehensive solution for the centralised management of smart public lighting, designed to work natively with NEXO Series communication nodes, based on LTE Cat 1 and Zhaga Book 18 connector.

This platform enables remote, real-time control of each luminaire, point by point, optimising energy consumption through dynamic luminous flux regulation and the programming of scenarios adapted to the needs of each urban area.

The system offers advanced monitoring and automatic alarm notifications, facilitating more predictive and efficient maintenance, reducing unnecessary travel and response times in the event of incidents.

Thanks to this smart management, municipalities can achieve significant savings in both lighting energy consumption and operational maintenance costs, contributing to sustainability, energy efficiency and emissions reduction goals.

Smart lighting.



Kalman Project platform

LTE Cat1



Web server (cloud)

LTE Cat1



Luminaires + NEXO Series node

KALMAN Project platform

- Real-time monitoring:** Instant display of the status of lighting points.
- Remote control:** Individual or group adjustments remotely.
- Calendar:** Daily, weekly, monthly or annual scheduling
- Reports and analysis:** Generation of reports on alarms and performance.
- Security:** Encrypted communications between the system and luminaires.
- User roles:** Customisable permissions according to profile.
- Scalability:** Easy integration of new lighting points.
- Inventory:** Complete record of connected luminaires.



NEXO Series node



- Connector:** Zhaga Book 18, compatible with standard LED luminaires.
- Plug & Play:** Direct coupling with twist-lock mechanism, no tools required.
- Automatic geolocation:** Integrated GPS for instant location.
- LTE Cat 1 communication:** Wide coverage, low consumption and high urban penetration.
- DALI-2 – D4i protocol:** Bidirectional communication and parameter reading.
- High protection rating:** IP66 / IK10

- Operational efficiency
- Greater reliability
- Flexibility and scalability
- Time and resource savings
- Cost optimisation
- Improved road safety
- Sustainability
- Traceability and centralised management

Project: San Sebastián Market
Location: Huelva, Andalucía
Luminaire: POTEL Series



movility: EV charger

122 – POTEL Series

121



MOBILITY

POTEL Series - EV Charger

POTEL Series



Installation on concrete base

The **POTEL Series** range is a professional solution for charging battery electric vehicles (BEVs) and plug-in hybrid electric vehicles (PHEVs).

It offers a power of 2 x 22 kW for semi-fast charging in Mode 3, allowing up to two vehicles to be charged simultaneously.

Ideal for public and private environments, it can be used by authorised users via RFID card or through an APP (Android or iOS).

Possibility of integration into management platforms based on OCPP 1.6J+.



Features

- Three-phase charger
- Single- or dual-output model for simultaneous charging
- Ideal for battery electric vehicles (BEVs) and plug-in hybrid electric vehicles (PHEVs)
- Charging control via RFID card or APP
- Floor mounting
- Public car parks and companies
- Connectivity via Wi-Fi, 4G and Ethernet
- Integrated MID meter

Dimensions

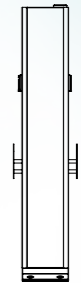
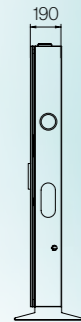
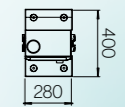
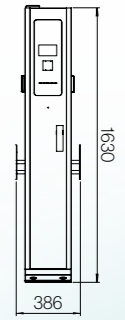

Possibility of integration into management platforms based on OCPP 1.6J+.



122

123



MOBILITY

POTEL Series - EV Charger

Series 1

Reference configurator

Model	Power	Input voltage	Output voltage	Connectivity	Connector	RAL color	Treatment
POT1 Series 1	P3 22 kW (32 A) + 22 kW (32 A)	40V Three-phase, 400 V AC	A3 2 three-phase outputs, 400 V AC	W4 WIFI + 4G	MEN Type 2 Mennekes (IEC 62196-2)	M3	GY RAL 7016 grey ** On request



Project: Carolina Marín Sports Palace Car Park
Location: Huelva, Andalucía
Luminaire: TESLA Series MAX



Projects



Project: Mazagón Seafront Promenade
Location: Palos de la Frontera, Huelva, Andalucía
Luminaire: TESLA Series PRO

Project: Cariño Town Council
Location: Cariño, A Coruña, Galicia
Luminaire: ROYALTY Series



Project: Cariño Town Council
Location: Cariño, A Coruña, Galicia
Luminaire: STELLA Series V





Project: Campo da Estrela Street
Location: Santiago de Compostela, A Coruña, Galicia
Luminaire: COANDA Series START

Project: Órgiva Town Council
Location: Órgiva, Granada, Andalucía
Luminaire: ROYALTY Series



134

Project: Maruja Mallo Park
Location: Vigo, Pontevedra, Galicia
Luminaire: BUSIER Series Start



Project: El Toboso Council
Location: El Toboso, Toledo, Castilla-La Mancha
Luminaire: ROYALTY Series





Project: Santiago Train Station
Location: Santiago de Compostela, A Coruña, Galicia
Luminaire: TESLA Series PRO



Project: Marbella Seafont Promenade
Location: Marbella, Málaga, Andalucía
Luminaire: FARO Series

Project: Moeche Town Council
Location: Moeche, A Coruña, Galicia
Luminaire: ROYALTY Series



Project: Numancia de la Sagra Town Council
Location: Numancia de la Sagra, Toledo, Castilla-La Mancha
Luminaire: OLO Series



140

Project: A Barca Bridge
Location: Pontevedra, Galicia
Luminaire: GAUDÍ Series



Project: Woodspring Suites
Location: Florida, USA
Luminaire: TESLA Series PRO



Project: As Gándaras Football Field
Location: Lugo, Galicia
Luminaire: LAMAR Series



144

Project: Skatepark Navia
Location: Vigo, Pontevedra, Galicia
Luminaire: GAUDÍ Series



Project: Municipal Football Field
Location: El Toboso, Toledo, Castilla-La Mancha
Luminaire: LAMAR Series



Project: A Malata Sports Centre
Location: Ferrol, A Coruña, Galicia
Luminaire: GAUDÍ Series



Project: San Sebastián Market
Location: Huelva, Andalucía
Luminaire: POTEL Series





Project: Outer Port of A Coruña
Location: A Coruña, Galicia
Luminaire: TESLA Series PRO

appendix

153

Description of the product pages

Each product is accompanied by its name, type, logo indicating the product line it belongs to, an image and a brief description. In addition, the most notable technical features are illustrated by means of icons.

On the following page, the features are shown together with a product drawing including its dimensions. Next, the different installation methods of the product and its photometric diagrams are indicated.

The screenshot shows a product page for the COANDA Series Mini - Street light. It includes a main image of the light fixture, a list of features, technical specifications, dimensions, and photometric diagrams. Labels on the left side of the image point to various elements: Name, Image, Installation type, Description, Line, Type, Features, Dimensions, and Photometric diagrams. At the bottom, a label points to the icons section.

This section contains a reference configurator, luminous flux tables according to power ratings and CCT, and on the following page there is a photograph of a project in which the luminaire has been installed.

The screenshot shows the reference configurator and luminous flux tables for the COANDA Series Mini - Street light. It includes a table with columns for Line, Name and type, Name and type, and Line. Below the table are two tables of luminous fluxes (Lúmenes and LPM) for different power ratings and CCT values. Labels on the left side of the image point to the Reference configurator and Luminous fluxes.

Icons



Product with Class I electrical insulation with all accessible metal parts forming the enclosure connected to an earth connection, so that accessible conductive parts cannot become hazardous in the event of a fault or anomaly in the main insulation.



Product with Class II electrical insulation designed in such a way that it does not require a protective earth connection. Protection against electric shock does not rely solely on the main insulation, but includes additional safety measures such as double insulation or reinforced insulation.



Product available with both Class I electrical insulation and Class II electrical insulation due to the possibility of using different configurations of components that make up the product's internal electronic circuit, enabling its operation.



(IEC/EN 62262) Protection rating that indicates, under a numerical classification, the resistance provided by the enclosure of the electrical product against external mechanical impacts. The IK rating ranges from 0 (minimum resistance) to 10 (maximum resistance).



(93/68/CEE) European marking established by the European Community indicating by the manufacturer that its product complies with the minimum legal/technical safety requirements of the Member States of the European Union.



(2011/65/UE) European Directive restricting, in the manufacturing process of electrical and electronic equipment (EEE), the use of hazardous substances listed in the directive itself: Pb, Hg, Cd, CrVI, PBB and PBDE, plus four types of phthalates, DEHP, BBP, DBP and DIBP, from Delegated Directive (EU) 2015/863 onwards.



(IEC/EN 60529) Protection rating that indicates, under a numerical classification, the protection provided by the enclosure against solid elements (first digit) and liquid elements (second digit). The IP rating ranges from 00 (no protection) to 68 (complete protection against solid elements and capable of withstanding continuous immersion).



(2012/19/UE) European Directive on Waste Electrical and Electronic Equipment (WEEE), which indicates that the product must be taken to collection points at the end of its service life and must not be disposed of together with other household waste.



Official marking of the IAC (Instituto Astrofísico de Canarias), which certifies that the product complies with the requirements set out in the Catalogue of Technical Specifications Applicable to Outdoor Lighting Installations subject to the Regulation of Law 31/1988 on the Protection of the Astronomical Quality of the Observatories of the Instituto de Astrofísica de Canarias.



Project: Sacaba Beach
Location: Málaga, Andalucía
Luminaire: STELLA Series V

contact

SANTIAGO DE COMPOSTELA

info@moonoff.com

+34 981 072 100

c/República Checa 23-25, P.E. Costa Vella
15707 Santiago de Compostela, España

 [LinkedIn.com/company/moonoff](https://www.linkedin.com/company/moonoff)

 [moonoff.com](https://www.moonoff.com)

 info@moonoff.com

157

© All rights reserved.

Moonoff reserves the right to modify the specifications and/or remove products from the collection at any time and without prior notice, as well as the right to introduce any technical, photometric, detail and finish modifications it deems appropriate in order to add an improvement or due to commercial and manufacturing requirements. Furthermore, it shall not be liable for any consequences resulting from the use of this publication.

VERSIÓN DE CATÁLOGO 2025_V2_EN

Project: Plaza España
Location: Vigo, Pontevedra, Galicia
Luminaire: GAUDÍ Series



notes

159

160





moonoff.com
info@moonoff.com

